



EXCLUSIVE
EDUCATOR CATALOG
2025-2026



503-362-2560

PERIPOLE.COM

PARTNERS IN MUSIC EDUCATION[®]



CONTENTS

Catalog Sections	Page #
■ Bergerault® Orff Instruments	5-17
■ Recorders and Wind Tones	18-20
• Peripole® Halo® Recorder.....	18
• Consort Recorders and Accessories	19
• Nuvo Recorders and Preband Instruments	20
• Unique Wind Tones.....	20
■ Mallets	21
■ Peripole® Percussion: Drums and Accessories	22-
• Peripole® Rainbow® Hand Drums.....	22
• Sienta® Series and Ngoma Drums	23
• Toca Drums.....	24-25
• African and Middle Eastern Drums	26-27
• South American and Caribbean Drums.....	28
• Cajons.....	29
• Congas and Bongos.....	23, 30-31
• Conga, Djembe, and Bongo Accessories.....	31
• Bodhrans and Accessories.....	32
• Tambourines.....	32
■ Percussion Packages	33-37, 48-49
• Personal Music Kits.....	33
• World Percussion Packages	34-35
• Peripole® Rhythm Sets.....	46-47
■ Peripole® Percussion: Hand Percussion	36-
• Wood Tones and Guiros.....	36-37
• Shakers and Scrapers.....	38-39
• Early Percussion.....	40
• Unique Percussive Tones.....	41
• Bell Tone Instruments	42-43
• Cymbals and Gongs.....	44
• Bell Kits.....	45
■ Adaptive Assistance	47
■ Boomwhackers	48
■ Note Knacks	49
■ Movement Props	50-51
■ Ukuleles	52-59
• Peripole® Classic Ukulele by Enya	52
• Enya Ukuleles.....	53-56
• Ukulele Classroom Sets	56
• Luna Ukuleles.....	57-59
■ Guitar and Ukulele Accessories	60-61
■ Guitars	62-65
• Quality Classroom Guitars	62
• Takamine Guitars	63
• Luna Guitars	63
• Electric Guitars.....	64
■ Guitar Classroom Sets	65
■ Dulcimers	66
■ Amplifiers and Accessories	66
■ Guitar and Ukulele Books and Resources	67
■ Drum Kits and Accessories	68-69
■ Pianos and Accessories	69
■ Technology-Microphones, PA Systems and Accessories	70-71
■ Music Stands, Racks and Storage	72-73
■ Publications and Media	74-77
■ Order Information	78-79



Follow us on social media for latest products and sales!



facebook.com/peripolemusic



@peripolemusic



@peripolemusic

Throughout this catalog many items are subject to special educator discounted pricing. Items marked with a star ★ are not subject to further discounts.

SHOP ONLINE PERIPOLE.COM

- Educator pricing online with registration
- Educational Articles in our "Resources" Section
- Sample videos
- Special offers
- Newly added products

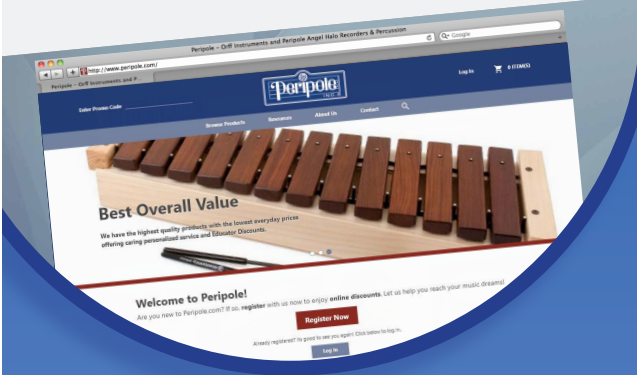

NEW EXCLUSIVE EDUCATOR CATLOG

We are excited to introduce our new Educator Exclusive Catalog for the 2025-2026 school year! In previous years, our catalog has listed the full list price of each item and you would need to call or make an educator account to get discounted pricing. This year, we have heard your feedback, and to make the buying process as easy as possible for teachers, we are introducing our newly formatted Educator Exclusive catalog with full discounted prices for your convince. Please note that the prices in this catalog are not available to the general public and are exclusively for educators, schools, and other educational institutions. To qualify for discounted pricing please either call our office at 503-362-2560, email our sales staff at contact@peripole.com, or register as a teacher or educational institution on our website at www.peripole.com.

PERIPOLE EXCLUSIVES

Over the years, Peripole has worked very hard to bring our customers the highest quality instruments at the best possible prices. Many of these have led to the development of our own exclusive product lines, some formed in partnership with other manufacturers. We are extremely proud of these products, and to be able to offer them to you exclusively:

- **Bergerault® Orff Instruments**
- **Peripole® Halo® Recorders by Angel**
- **Peripole® Classic™ Ukuleles by Enya**
- **Peripole® Percussion**



Cooperative Purchasing Partners

Peripole, Inc. is an awarded vendor with several cooperative purchasing agencies. These agencies create and award a bid, on a state and / or national level which can be utilized or "piggy-backed" on by any school or non-profit institution. In this way schools, churches, and other non-profits, who do not have the resources to issue and award bid quotations can know that they are receiving the best value and price, while fulfilling requirements for competitive bidding. For more information contact our sales department at contact@peripole.com or by telephone at (800) 443-3592.



STILL MAKING MUSIC "GREEN"

Being "in harmony" means a lot of things to a lot of people. But as our planetary time passes and populations grow, it has become critical to consider the long term health and harmony of not only the people and other living things that inhabit the earth, but also the health of the living ecosystems of the planet itself.

Peripole, Inc. has always taken this commitment seriously from the time when we began our own program to reuse shipping boxes in 1992 to the present when we have completed an extensive insulation project including replacement of all of the large size windows on our building with energy conserving ones, thus yielding a smaller "carbon footprint". In 2008 we took the additional step

of purchasing 100% of the electrical power we use from renewable "green" sources.

You may have noticed that we favor natural, biodegradable, renewable and recyclable materials in the construction of our instruments and in our packaging materials. This is not an accident. We seek to avoid using products that are harmful to the environment and to individual health, and we favor natural authentic materials such as wood and tunable skins for drums, but always with an eye to quality.

A Different Kind of Beginning

The year was 1945. World War II was near its end, but still raging in Europe and in the Pacific. A couple of young music educators and parents decided to turn their talents toward making instruments for music education in elementary schools.

Sylvia and Mack Perry named their fledgling business "Peripole." Their first product was their signature "Tymptone" drum which due to new materials and resource scarcity, was made in the living room of their apartment in Brooklyn, NY, from recycled and salvaged materials. Each drum was hand-painted by Sylvia.

The Perrys were soon delighted to receive an order from the famous Macy's department store in New York City, delivered directly by the couple by baby carriage.

The years that followed saw Sylvia and Mack take Peripole out of their living room and into a storefront building. There was no one else making musical instruments for general music education at the time, and the Perrys saw rapid growth in Peripole. They took over the store next door, then the one next to that, and finally moved into a commercial factory building.

In the early 1960s, established leaders in their field, the Perrys forged an alliance with the Orff-Schulwerk movement in Europe and made history by becoming the first company

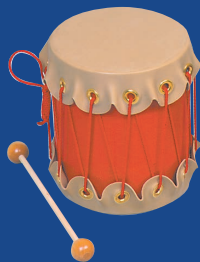

to import Orff instruments into the United States for sale to schools. The Perrys were also charter members of AOSA. In 1974, after launching two famous brands of Orff instruments in the United States, the Perrys made a new partnership with the Bergerault company in France, having finally found a company whose Orff instrument quality matched their own high standards of manufacture.

In 1992, seven years after Mack's death, company founder Sylvia Perry moved to Salem, Oregon, to join forces with her son, now company president, Dr. Andrew Perry. In 2015, Peripole welcomed Ami Halverson (née Perry) to the company. Ami brings a renewed vigor and excitement to Peripole as well as the continuation of the company family.



Andrew Perry,
President
Peripole



Ami Halverson,
Vice President
Peripole

PARTNERS IN MUSIC EDUCATION®

Every year, Peripole Music makes major contributions to the support of music education, locally and nationally.

Contributions Have Included:

- Sponsorship of keynote and other presenters at local, state, and national music educators' conferences and in-service days.
- Provision of session room instruments, including Bergerault® Orff Instrumentarium, at conferences, clinics, and courses nationwide.
- Donation of Instruments to non-profit music education organizations such as NAFME and AOSA.
- Donations of Peripole® Angel Halo® Recorders to Orff training courses across the country.
- Donation of door prizes and special awards at conventions, courses, and chapter meetings nationwide.
- Donation of instruments to schools hit by natural disasters.
- Donation of instruments to schools in other countries coping with poverty, political strife, and natural disasters.
- Special discounts to selected title one schools.

We are very proud of these contributions to music education. In the years since this program began, the need for it has grown exponentially and we have endeavored to rise to the challenge. We thank all of our loyal customers who have supported us and have enabled us to be in a position where we are able to return something to the music education community.



BERGERAULT®

*Experience
the best!*

ORFF INSTRUMENTS

PLEASE CONTACT
US IF YOUR
SCHOOL OR
DISTRICT REQUIRE
A SOLE SOURCE
LETTER



Exclusive Distributors

Tradition Founded by instrumental and mechanical genius, Albert Bergerault in 1932, the Bergerault Company has continued in France for three generations, each training the next.

Expertise From the selection of rosewood for optimum physical properties for sound production; to tuning, bar dimensions, and style; Bergerault has painstakingly explored and found the techniques needed to construct great instruments. These techniques are present in their world-renowned mallet percussion instruments as well as Bergerault® Orff instruments.

Quality The These select features are detailed in the Specification sections of each instrument.

Service Peripole, Inc. is the exclusive North American source of Bergerault® Orff Instruments. We provide service, parts, and expert consultation regarding our instruments which are backed by our Triple Guarantee! (See pg. 79)



Carefully selected rosewood lies in storage, awaiting further conditioning. Bergerault's rosewood is aged a minimum of six years prior to use, then conditioned hermetically to further gradually diminish moisture content.

Below photos, left to right: 1) Albert Bergerault with one of his early multiple instrument inventions. 2) Colette Fergeau (née Bergerault) is shown receiving the French Legion of Honor Chevalier Medal from the Government of France for her work with Bergerault. 3) Gilles Fergeau modernized the design and manufacturing of Bergerault® products, and is responsible for many of Bergerault's most notable product innovations. 4) Mathieu Fergeau receiving the "Entreprise du Patrimoine Vivant" or "Company of Living Heritage" award from the French Government.

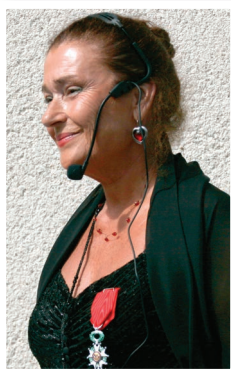
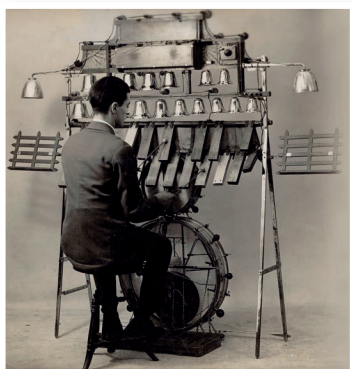



BERGERAULT® ROSEWOOD BAR XYLOPHONES

DIATONIC

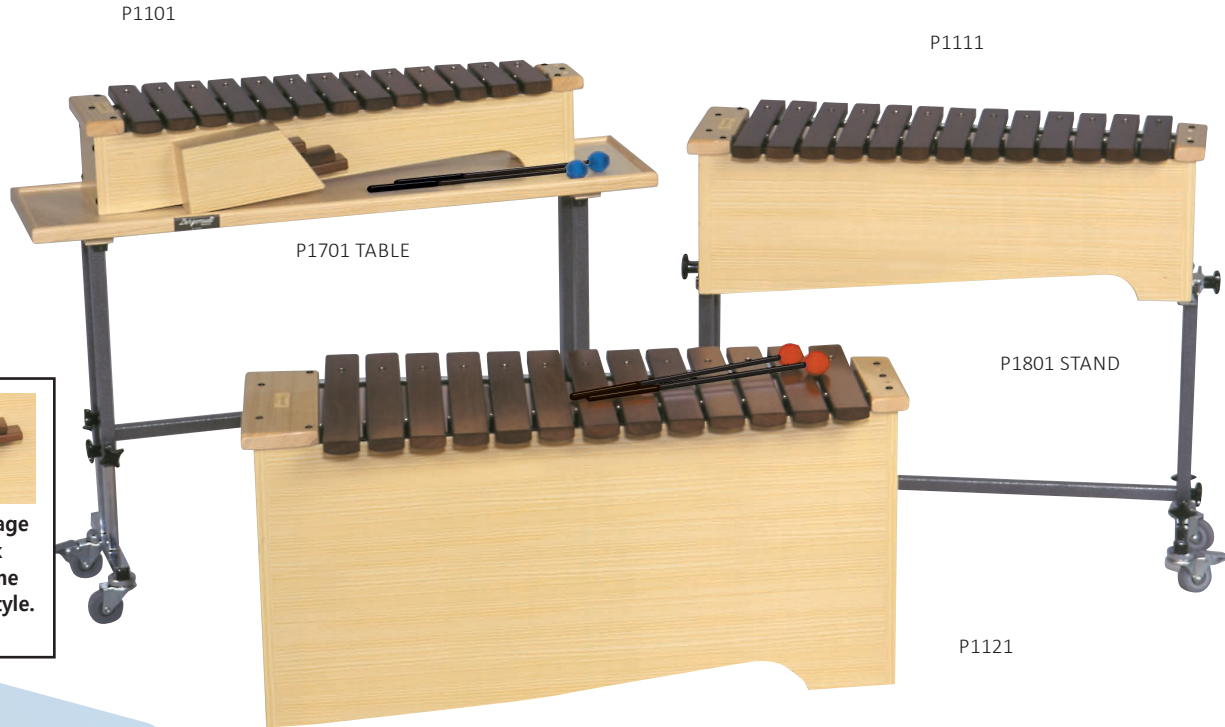

FREE attached bar storage box is now on the back side of instrument. Some photos still show old style.

CHROMATIC ADDITIONS

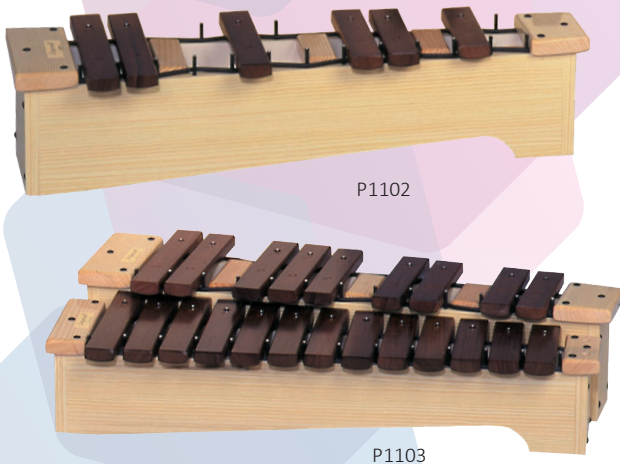

Note: F# and Bb bars are always included with diatonic instruments and should therefore be added to chromatic sections purchased to complete the full chromatic instrument.

DIATONIC INSTRUMENTS – SINGLE ROW

Includes F# and Bb bars with FREE attached wood storage box to hold these bars. Two quality wound mallets included with each instrument. 16 bars each. Please refer to octave range chart on page 11.

P1101	(XSD)	SOPRANO (C5-A6)	\$739.95 \$628.96
P1111	(XAD)	ALTO (C4-A5)	\$989.95 \$841.46
P1121	(XBD)	BASS (C3-A4)	\$1999.95 \$1,699.96
P1131	(XTAD)	TENOR ALTO (C4-C6)	\$1124.95 \$956.21

ADD-ON CHROMATIC SECTIONS (ONLY)

Extra resonator box with 6 bars only- C#, D#, G#, c#, d#, g# for each model. No mallets. F# and Bb bars supplied with diatonic instruments.

† P1102	(XSCH)	SOPRANO	\$559.95 \$475.96
† P1112	(XACH)	ALTO	\$749.95 \$637.46
† P1122	(XBCH)	BASS	\$1095.95 \$931.56
P1132	(XTACH)	TENOR ALTO	\$804.95 \$684.21

COMPLETE CHROMATIC INSTRUMENTS DOUBLE ROW – TWO RESONATOR BOXES

Combination of one diatonic and one chromatic section (above) to comprise a complete chromatic instrument. Two quality wound mallets included with each instrument. 22 bars each (25 bars for P1133).

† P1103	(XSD + XSCH)	SOPRANO	\$1299.90 \$1,104.92
† P1113	(XAD + XACH)	ALTO	\$1739.90 \$1,478.92
† P1123	(XBD + XBCH)	BASS	\$3095.90 \$2,631.52
P1133	(XTAD + XTACH)	TENOR ALTO	\$1929.90 \$1,640.42

† Not Illustrated



Educator or Educational institution status is required for discounted pricing featured in this catalog.

XYLOPHONE SPECIFICATIONS

(see diagram - bottom right)

Rosewood Bar Quality:

1. Removable bars made of prime, high-density rosewood, **aged at least six years**, with additional special de-humidification treatment, for precise control of moisture content, thus ensuring long-term accuracy of tuning and pitch, even in humid climates.
2. Rich, resonant rosewood sonority throughout the entire range.
3. Flawless grain and finish.

Techlon Bar Quality:

1. **Bergerault® Techlon** is a unique proprietary composite material that has a sound closer to rosewood than other synthetic bars.
2. Surpasses other fiberglass/synthetic bar instruments in richness of tone quality.
3. Provides maximum protection from variations in humidity.

Bar Features:

4. **Extra-wide** bars precisely tuned to A440, and overtone-tuned. Bars range in size from 1 7/8" wide x 5/8" thick for the Soprano and Alto models to 2" wide x 5/8" thick for Bass models. Professional size bars enhance sonority.
5. Holes for placement of bars on the pegs are countersunk for easy placement and removal of bars.
6. Long-lasting, neoprene covered, heavy-duty metal posts to hold bars with solid neoprene bar support.

Resonator Boxes:

7. Built-in mallet storage on each instrument.
8. Box constructed of solid hardwood and covered externally with laminate finish for durability and easy cleaning.
9. Top and sides both glued and screwed together.
10. Solid design construction at base of instrument for greater strength.
11. Interior partitions capped for finished look.
12. Interior boxes specially tuned.
13. **FREE attached wood storage box** to hold F# and Bb bars.
14. Resonator box interior design for optimal and equal resonance.
15. Lift ledges for easy carrying.

It took 10 years of design and research to create the composite materials used in our Bergerault® Techlon Xylophone Bars in order to satisfy our uncompromising high quality standards!



P1121C

DIATONIC INSTRUMENTS

Includes F# and Bb bars with FREE attached wood storage box to hold these bars. Two quality wound mallets included with each instrument. 16 bars each. Please refer to octave range chart on page 9.

†P1101C (XSD)	SOPRANO (C5-A6)	\$739.95 \$665.96
†P1111C (XAD)	ALTO (C4-A5)	\$989.95 \$890.96
P1121C (XBD)	BASS (C3-A4)	\$1999.95 \$1,799.96
†P1131C (XTAD)	TENOR-ALTO (C4-C6)	\$1124.95 \$1,012.46

ADD-ON CHROMATIC SECTIONS

Extra resonator box with 6 bars only- C#, D#, G#, c#, d#, g# for each model. No mallets. F# and Bb bars supplied with diatonic instruments.

†P1102C (XSCH)	SOPRANO	\$559.95 \$503.96
†P1112C (XACH)	ALTO	\$749.95 \$674.96
†P1122C (XBCH)	BASS	\$1095.95 \$986.36
†P1132C (XTACH)	TENOR-ALTO	\$804.95 \$724.46

COMPLETE CHROMATIC INSTRUMENTS

Combination of one diatonic and one chromatic section (above) to comprise a complete chromatic instrument. Two quality wound mallets included with each instrument. 22 bars each (25 bars for P1133C).

†P1103C (XSD+XSCH)	SOPRANO	\$1299.90 \$1,169.91
†P1113C (XAD+XACH)	ALTO	\$1739.90 \$1,565.91
†P1123C (XBD+XBCH)	BASS	\$3095.90 \$2,786.31
†P1133C (XTAD+XTACH)	TENOR-ALTO	\$1929.90 \$1,736.91

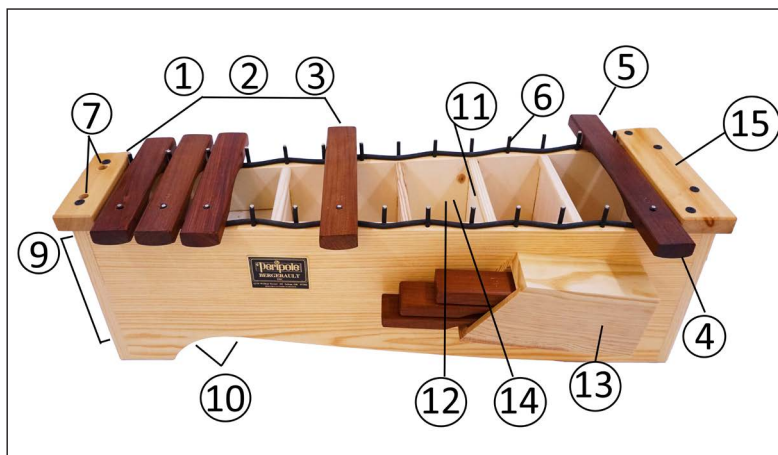

† Not Illustrated



DIATONIC



DAMPERS AND STORAGE FOR EXTRA NOTES INCLUDED!

† Not Illustrated



P1331

CHROMATIC ADDITIONS

Note: F# and Bb bars are always included with diatonic instruments and should therefore be added to chromatic sections purchased to complete the full chromatic instrument.

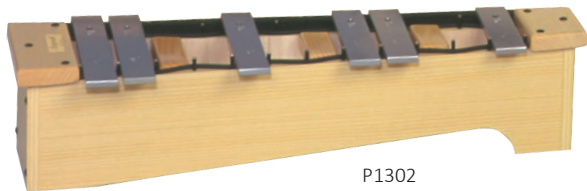

P1302

† Not Illustrated



P1303

DIATONIC INSTRUMENTS – SINGLE ROW

Includes F# and Bb bars with FREE attached wood storage box to hold these bars. Two quality wound mallets included with each instrument. 16 bars each. Please refer to octave range chart on page 9.

P1301	(MSD)	SOPRANO (C5-A6)	\$749.95.....	\$637.46
P1311	(MAD)	ALTO (C4-A5)	\$989.95.....	\$841.46
P1321	(MBD)	BASS (C3-A4)	\$1999.95.....	\$1,699.96
P1331	(MTAD)	TENOR-ALTO (C4-C6)	\$1129.95.....	\$960.46

ADD-ON CHROMATIC SECTIONS (ONLY)

Extra resonator box with 6 bars only- C#, D#, G#, c#, d#, g# for each model. No mallets. F# and Bb bars supplied with diatonic instruments.

P1302	(MSCH)	SOPRANO	\$595.95.....	\$506.56
† P1312	(MACH)	ALTO	\$724.95.....	\$616.21
† P1322	(MBCH)	BASS	\$1095.95.....	\$931.56
† P1332	(MTACH)	TENOR-ALTO	\$859.95.....	\$730.96

COMPLETE CHROMATIC INSTRUMENTS DOUBLE ROW – TWO RESONATOR BOXES

Combination of one diatonic and one chromatic section (above) to comprise a complete chromatic instrument. Two quality wound mallets included with each instrument. 22 bars each (25 bars for P1333).

P1303	(MSD + MSCH)	SOPRANO	\$1345.90.....	\$1,144.02
† P1313	(MAD + MACH)	ALTO	\$1714.90.....	\$1,457.67
† P1323	(MBD + MBCH)	BASS	\$3095.90.....	\$2,631.52
† P1333	(MTAD+MTACH)	TENOR-ALTO	\$1989.90.....	\$1,691.42



Educator or Educational institution status is required for discounted pricing featured in this catalog.

METALLOPHONE SPECIFICATIONS

Bar Features:

- ① Thick, **extra-wide**, bell-aluminum bars, ranging in size from 1 5/8" wide x 5/16" thick for the Soprano and Alto models to 2" wide x 1/2" thick for the Bass models. Professional size bars enhance sonority.
- ② Rich, resonant tone throughout the entire range.
- ③ Removable bars each precisely tuned to A440 and overtone-tuned.
- ④ Holes for placement of bars on pegs are countersunk for easy placement and removal.
- ⑤ Long-lasting neoprene covered heavy-duty metal posts to hold bars with solid neoprene bar support.

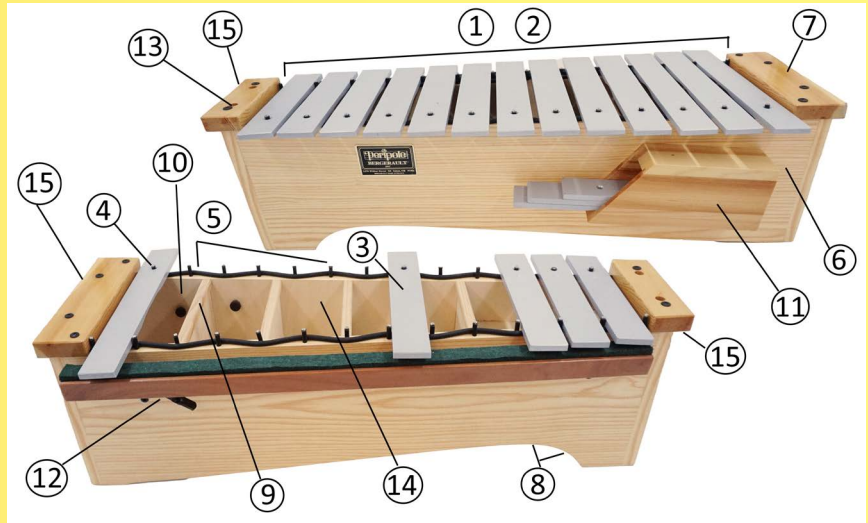

Resonator Boxes:

- ⑥ Box constructed of solid hardwood and covered externally with laminate finish for durability and easy cleaning.
- ⑦ Top and sides both glued and screwed together.
- ⑧ Solid design construction at base of instrument for greater strength and durability.
- ⑨ Interior partitions capped to prevent buzzing.
- ⑩ Interior boxes individually tuned.
- ⑪ **FREE** attached wood storage box to hold F# and Bb bars.
- ⑫ **FREE** attached adjustable dampers.
- ⑬ Built in mallet storage on each instrument.
- ⑭ Resonator box interior designed for optimal and equal resonance.
- ⑮ Lift ledges for easy carrying.

SCIENTIFIC PITCH NOTATION CHART

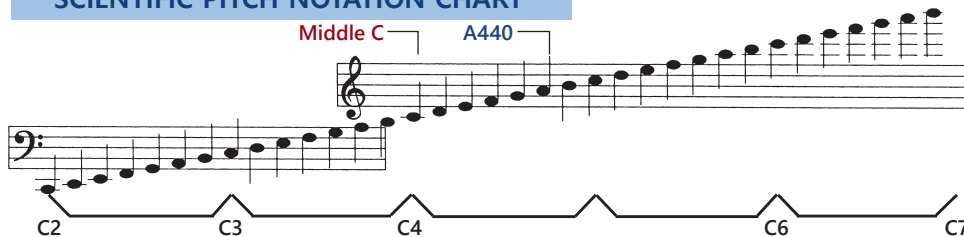

ORFF INSTRUMENT RANGES

- Contra-Bass Bars (C2-C3)
- Bass Xylophone, Bass Metallophone (C3-A4)
- Alto Xylophone, Alto Metallophone (C4-A5)
- Soprano Xylophone, Soprano Metallophone
- Alto Glockenspiel (C5-A6)
Alto glockenspiel and soprano metallophone are same octave but different timbre.
- Soprano Glockenspiel (C6-A7)

RECORDER RANGES

- Sopranino Recorder (F5-G7)
- Soprano Recorder (C5-A7)
- Alto Recorder (F4-G6)
- Tenor Recorder (C4-A6)
- Bass Recorder (F3-G5)

★ Starred items already discounted, not subject to further discounts — NET PRICES



The musical instruments in our catalog are not toys. They are intended for use by adults and children with adult supervision. Unless otherwise stated, the instruments are not recommended for children under 3 years of age.





BERGERAULT® GLOCKENSPIELS

Bright, sparkling sound and timbre that's preferred by many music educators.

WIDE BAR

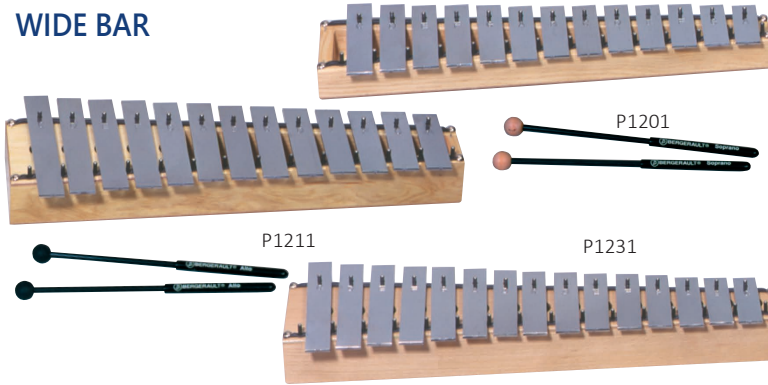

Smooth, rich tone with extra-wide bars for easier targeting.

CLASSIC

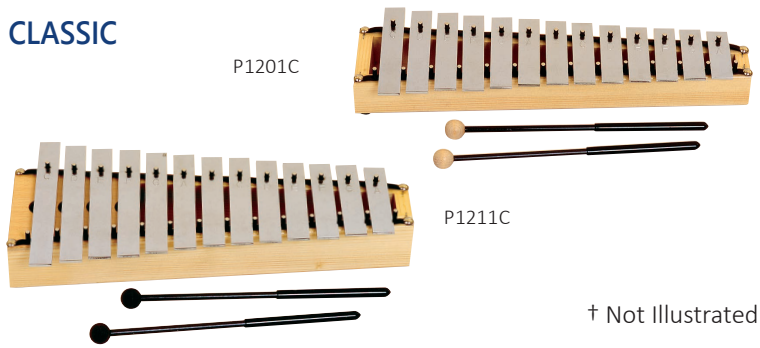

† Not Illustrated

CHROMATIC ADDITIONS

Note: F# and Bb bars are always included with diatonic instruments and should therefore be added to chromatic sections purchased to complete the full chromatic instrument.

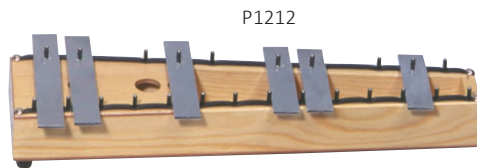

Educator or Educational institution status is required for discounted pricing featured in this catalog.

DIATONIC INSTRUMENTS – SINGLE ROW

Includes F# and Bb bars. Two mallets included with each instrument. 16 bars each. Please refer to octave range chart on page 9.

WIDE BAR

P1201	(CSD)	SOPRANO (C6-A7)	\$229.95..... \$195.46
P1211	(CAD)	ALTO (C5-A6)	\$259.95..... \$220.96
P1231	(CTAD)	TENOR-ALTO (C5-C7)	\$329.95..... \$280.46

CLASSIC

P1201C	(CSD)	SOPRANO (C6-A7)	\$229.95..... \$206.96
P1211C	(CAD)	ALTO (C5-A6)	\$259.95..... \$233.96
†P1231C	(CTAD)	TENOR-ALTO (C5-C7)	\$329.95..... \$296.96

ADD-ON CHROMATIC SECTIONS (ONLY)

Extra resonator box with 6 bars only- c#, d#, g#, c#, d#, g # for each model. No mallets. F# and Bb bars supplied with diatonic.

WIDE BAR

†P1202	(CSCH)	SOPRANO	\$129.95..... \$110.46
P1212	(CACH)	ALTO	\$169.95..... \$144.46
†P1232	(CTACH)	TENOR-ALTO	\$259.95..... \$220.96

CLASSIC

†P1202C	(CSCH)	SOPRANO	\$129.95..... \$116.96
†P1212C	(CACH)	ALTO	\$169.95..... \$152.96

COMPLETE CHROMATIC INSTRUMENTS DOUBLE ROW – TWO RESONATOR BOXES

Combination of one diatonic and one chromatic section (above) to comprise a complete chromatic instrument. Two mallets included with each instrument, 22 bars each (25 bars for P1233 & P1233C).

WIDE BAR

†P1203	(CSD + CSCH)	SOPRANO	\$359.90..... \$305.92
†P1213	(CAD + CACH)	ALTO	\$429.90..... \$365.42
†P1233	(CTAD + CTACH)	TENOR-ALTO	\$589.90..... \$501.42

CLASSIC

†P1203C	(CSD + CSCH)	SOPRANO	\$359.90..... \$323.91
†P1213C	(CAD + CACH)	ALTO	\$429.90..... \$386.91

GLOCKENSPIEL SPECIFICATIONS

Wide Bar Quality:

- ① **Extra-wide** chrome steel bars 1" wide x 1/8" thick provide richer, smooth sound and protect against oxidation.
- ② Wider bars allows easier and more accurate targeting.
- ③ Removable bars precisely tuned to A440.

Classic Bar Quality:

- ① Special chrome tempered steel bars 3/4" wide x 1/8" thick, provides distinctive bright timbre and protect against oxidation.

Resonator Boxes:

- ① Solid wood resonator boxes.
- ② Heavy-duty neoprene covered metal posts to hold bars with solid neoprene bar support. Never needs replacement with normal use.

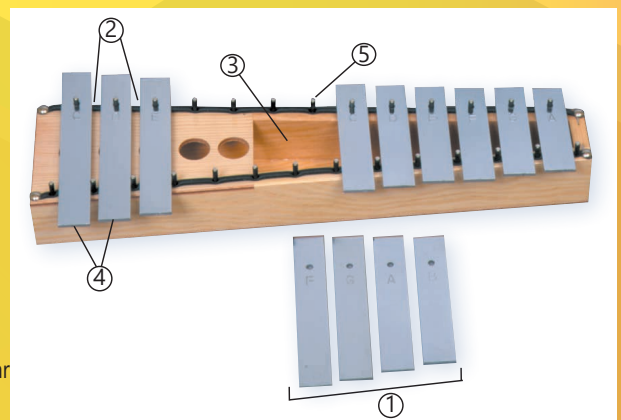

Our Compact Series Orff Instruments are designed for ease of use in the modern school environment.

SPECIFICATIONS

- Extra-wide, extra-long bars identical to our Standard and Chromatic Orff models for superior sound. (See pages 9 and 11 for bar dimensions and specifications.)
- Range identical to standard Orff instruments.
- Long-lasting, heavy-duty metal bar posts with solid neoprene cord to support bars and allow free vibration.
- Perfect alignment of bars of diatonic instruments and chromatic add-on units with innovative half-trapezoid shape.
- Natural wood varnished resonator boxes.
- Compact and stackable for easy storage and transport.
- Please refer to octave range chart on page 11.

Note: F[#] and B^b bars are always included with diatonic instruments and should therefore be added to chromatic sections purchased to complete the full chromatic instrument.

★ Starred items already discounted, not subject to further discounts — NET PRICES

XYLOPHONES



P1111CP

P1101CP

P1111CP

P1113CP

METALLOPHONES

P1301CP

P1311CP

P1303CP

DIATONIC XYLOPHONES – SINGLE ROW

Includes F[#] and B^b bars and two quality wound mallets. 16 bars.

P1101CP	(XSD)	Soprano (C5-A6)	Rosewood	\$529.95★
† P1101CPC	(XSD)	Soprano (C5-A6)	Techlon	\$529.95★
P1111CP	(XAD)	Alto (C4-A5)	Rosewood	\$689.95★
† P1111CPC	(XAD)	Alto (C4-A5)	Techlon	\$689.95★

ADD-ON CHROMATIC SECTIONS (ONLY)

Extra resonator box with 6 bars only- C[#], D[#], G[#], c[#], d[#], g[#] for each model.

No mallets. F[#] and B^b bars supplied with diatonic instruments.

† P1102CP	(XSCH)	Soprano	Rosewood	\$379.95★
† P1102CPC	(XSCH)	Soprano	Techlon	\$379.95★
P1112CP	(XACH)	Alto	Rosewood	\$499.00★
† P1112CPC	(XACH)	Alto	Techlon	\$499.00★

COMPLETE CHROMATIC XYLOPHONES DOUBLE ROW – TWO RESONATOR BOXES

Combination of one diatonic and one chromatic section (above) to comprise a complete chromatic instrument. Two quality wound mallets. 22 bars.

† P1103CP	(XSD + XSCH)	Soprano	Rosewood	\$909.90★
† P1103CPC	(XSD + XSCH)	Soprano	Techlon	\$909.90★
P1113CP	(XAD + XACH)	Alto	Rosewood	\$1,188.95★
† P1113CPC	(XAD+XACH)	Alto	Techlon	\$1,188.95★

† Not Illustrated

DIATONIC METALLOPHONES – SINGLE ROW

Includes F[#] and B^b bars and two quality wound mallets. 16 bars.

P1301CP	(MSD)	Soprano (C5-A6)	\$529.95★
P1311CP	(MAD)	Alto (C4-A5)	\$689.95★

ADD-ON CHROMATIC SECTIONS (ONLY)

Extra resonator box with 6 bars only- C[#], D[#], G[#], c[#], d[#], g[#] for each model.

No mallets. F[#] and B^b bars supplied with diatonic instruments.

† P1302CP	(MSCH)	Soprano	\$379.95★
P1312CP	(MACH)	Alto	\$499.95★

COMPLETE CHROMATIC METALLOPHONES DOUBLE ROW – TWO RESONATOR BOXES

Combination of one diatonic and one chromatic section (above) to comprise a complete chromatic instrument. Two quality wound mallets included. 22 bars.

† P1303CP	(MSD + MSCH)	Soprano	\$909.90★
P1313CP	(MAD + MACH)	Alto	\$1,189.90★



BERGERAULT®

JUNIOR PROFESSIONAL

For More Advanced Work in Orff Schulwerk

- Complete Chromatic Instruments.
- Tuned tubular resonators create consistent concert hall sound.
- Intrinsic stands and wheels for easy mobility.
- Removable bars, adjustable height.



Educator or Educational institution status is required for discounted pricing featured in this catalog.

Features foot-pedal damper like a professional vibraphone!



JUNIOR PROFESSIONAL CHROMATIC METALLOPHONES

AN ORIGINAL AND EXCLUSIVE BERGERAULT® CONCEPT!

JUNIOR PROFESSIONAL CHROMATIC METALLOPHONES

(with foot-pedal damper) Mallets included

P1503	(PMSCH)	Soprano (C5-A6)	\$1299.95 \$1,104.96
P1513	(PMACH)	Alto (C4-A5)	\$1699.95 \$1,444.96
P1523	(PMBCH)	Bass (C3-A4)	\$3299.95 \$2,804.96

METALLOPHONE SPECIFICATIONS

- Identical to Metallophone – unique superior features and detailed specifications listed on page 11.
- Individual precision-tuned aluminum resonator tubes under each removable bar create perfect equal resonance.
- Entire section of resonator tubes joined together as a single removable unit.
- Sturdy, collapsible square tubular steel legs.
- Telescoping legs adjustable for height.
- Solid hardwood used in frame construction and covered externally with laminate finish for durability and easy cleaning.
- Foot-pedal damper with telescoping steel rod adjustment allows for setting to perfect height.

ALL BLUES

P9188 \$38.00★

By Doug Goodkin

- 22 Classic, jazz, blues tunes arranged for the Orff ensemble and other groups
- Blues-based games and songs for preschool and elementary children
- Great for use with both Bergerault® diatonic and chromatic Orff Instruments!

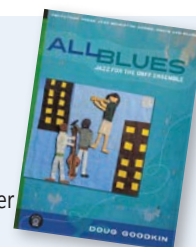

See page 74-77 for complete publications list.

BERGERAULT CHROMATIC GLOCKENSPIEL

P1240 \$219.95..... \$186.96

Soprano chromatic glockenspiel with 20 steel lacquered removable bars. From C6-G7. Includes 1 pair of mallets.

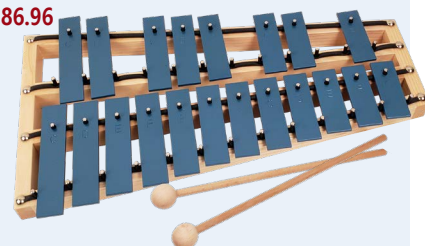

CHROMATIC ORFF INSTRUMENTS



Exclusive Distributors

JUNIOR PROFESSIONAL CHROMATIC XYLOPHONES



The musical instruments in our catalog are not toys. They are intended for use by adults and children with adult supervision. Unless otherwise stated, the instruments are not recommended for children under 3 years of age.

Refer to page 9 for range chart

★ Starred items already discounted, not subject to further discounts — NET PRICES
PRICES SUBJECT TO CHANGE WITHOUT NOTICE

CARE OF ROSEWOOD BARS

Since Bergerault® Rosewood Bars are of the highest quality and well-aged, they only require occasional cleaning with normal care and usage.

For optimal care of your rosewood instrument, we offer the following care instructions:

- Whenever possible, avoid extremes in temperature and humidity.
- Instruments should not be stored in front of windows, radiators, air ducts, or direct sunlight.
- After extensive use, bars may be cleaned with lemon oil (containing no silicones, linseed oil, or beeswax). Apply sparingly and polish vigorously with a soft dry cloth.

XYLOPHONE SPECIFICATIONS

- Aged rosewood bar and Techlon bar features and detailed specifications listed on page 9.
- Individual precision-tuned aluminum resonator tubes under each removable bar create perfect equal resonance.
- Entire section of resonator tubes joined together as a single removable unit.
- Sturdy, collapsible square tubular steel legs.
- Telescoping legs adjustable for height.
- Solid hardwood used in frame construction and covered externally with laminate finish for durability and easy cleaning.

JUNIOR PROFESSIONAL ROSEWOOD CHROMATIC XYLOPHONES (Aged Rosewood Bars) Mallets included

P1603	(PXSCH)	Soprano (C5-A6)	\$1299.95 \$1,104.96
P1613	(PXACH)	Alto (C4-A5)	\$1699.95 \$1,444.96
P1623	(PXBCH)	Bass (C3-A4)	\$3299.95 \$2,804.96

JUNIOR PROFESSIONAL TECHLON CHROMATIC XYLOPHONES (Techlon Bars) Mallets included

† P1603C	(PXSCH)	Soprano (C5-A6)	\$1299.95 \$1,169.96
† P1613C	(PXACH)	Alto (C4-A5)	\$1699.95 \$1,529.96
† P1623C	(PXBCH)	Bass (C3-A4)	\$3299.95 \$2,969.96

† Not Illustrated



★ Starred items already discounted, not subject to further discounts — NET PRICES

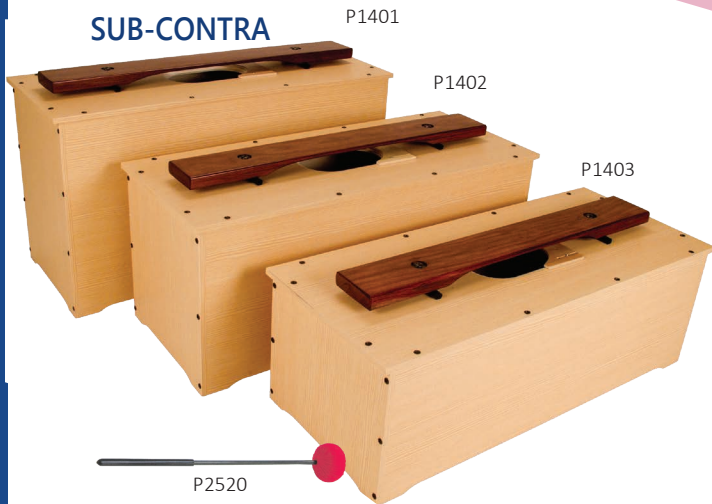

SUB-CONTRA

Rosewood
(3³/₄" X 3³/₄")

P1401	C	\$699.95.....	\$594.96
P1402	D	\$699.95.....	\$594.96
P1403	E	\$699.95.....	\$594.96

Techlon
(2³/₈" X 5⁵/₈")

P1401C		\$699.95.....	\$629.96
†P1402C		\$699.95.....	\$629.96
†P1403C		\$699.95.....	\$629.96

CONTRA

Rosewood
(3⁵/₃₂" X 3³/₄")

P1404	F	\$559.95.....	\$475.96
P1405	G	\$559.95.....	\$475.96
P1406	A	\$559.95.....	\$475.96
P1407	B	\$559.95.....	\$475.96
P1408	Hi C	\$529.95.....	\$450.46

Techlon
(2³/₈" X 5⁵/₈")

†P1404C		\$559.95.....	\$503.96
†P1405C		\$559.95.....	\$503.96
†P1406C		\$559.95.....	\$503.96
†P1407C		\$559.95.....	\$503.96
†P1408C		\$529.95.....	\$476.96

CHROMATIC

Rosewood

†P1411	C#	\$699.95.....	\$594.96
†P1412	D#	\$699.95.....	\$594.96
†P1413	F#	\$559.95.....	\$475.96
†P1414	G#	\$559.95.....	\$475.96
†P1415	Bb	\$559.95.....	\$475.96

Techlon

†P1411C		\$699.95.....	\$629.96
†P1412C		\$699.95.....	\$629.96
†P1413C		\$559.95.....	\$503.96
†P1414C		\$559.95.....	\$503.96
†P1415C		\$559.95.....	\$503.96

CONTRA

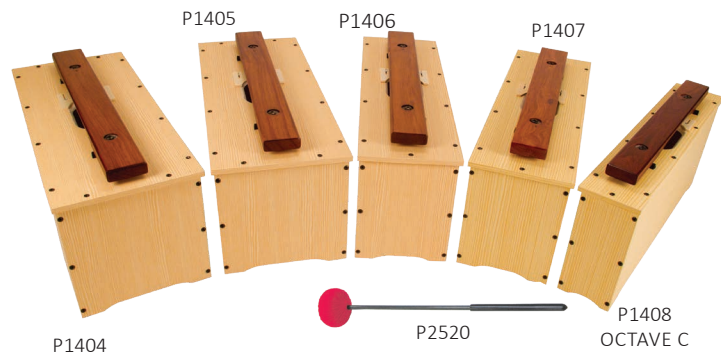
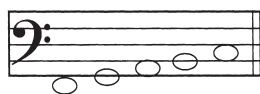

CONTRA BASS MALLET

P2520 \$19.95.... \$15.96

Specially fabricated 2" wound mallet designed to produce richest possible tone quality. NOT INCLUDED with CONTRA BASS BARS. Should be ordered separately. Please see page 23.

† Not Illustrated

CONTRA BASS BAR SPECIFICATIONS

Rosewood Bar Quality:

- Prime, high-density, individual bars, **aged at least six years** for precise control of moisture content, thus ensuring long-term accuracy of tuning and pitch, even in humid climates.
- Deep, rich, penetrating marimba quality. Indeed, these rosewood bars are the very same bars as those on our Professional Bass Marimba.
- Flawless, professional grain and finish.

Bar Features:

- Bars mounted on individual tuned wood resonator boxes **with additional adjustable tuning mechanism.**
- Bars precisely tuned to A440.
- **Each bar overtone-tuned to both the first and second overtones (tonic and dominant).**

Resonator Boxes:

- Constructed of wood with laminate finish for durability and easy cleaning.
- Top and sides both glued and screwed together.

TECHLON BASS BARS



P1401C-C

Synthetic Bar Quality:

- **Bergerault® Techlon** is a unique proprietary composite material that closely approximates the sound of rosewood.
- Surpasses other fiberglass/synthetic bar instruments in richness of tone quality.
- Provides maximum protection from variations in humidity.

ORFF TABLES & STANDS



Exclusive Distributors

BERGERAULT® ORFF INSTRUMENTS

DOUBLE-BRACED TABLES WITH WHEELS

P1701	For all Soprano and Alto Diatonic Glockenspiels, Metallophones and Xylophones	\$379.95 \$322.96
P1702	For Bass Diatonic Metallophones and Xylophones	\$399.95 \$339.96
† P1703	For all Soprano and Alto Chromatic Glockenspiels, Metallophones and Xylophones – excellent table to hold Sub-Contrabass and Contra Bass Bars	\$459.95 \$390.96
† P1704	For Bass Chromatic Metallophones and Xylophones	\$469.95 \$399.46
† P1705	Table for Compact Series Soprano and Alto Diatonic Instruments	\$399.95 \$339.96
† P1706	Table for Compact Series Soprano and Alto Complete Chromatic Instruments	\$329.00 \$279.65



P1701 Soprano/Alto Diatonic Table holds up to two Glockenspiels.

BERGERAULT® TABLE SPECIFICATIONS

- **Highly varnished wood** rectangular tables.
- **Raised ledges to keep instruments from slipping off.**
- **Sturdy steel, square tubular, double-braced** legs with highly durable textured epoxy and chrome finish fold under for storage with steel cross bar to enhance stability.
- **Heavy-duty wheels** for smooth mobility with **locking brakes.**
- **Height adjustable** telescoping legs.
- **Dismantles** for easy storage.
- **Quality French** manufacturing – free of lead based paints.



P1702

DOUBLE-BRACED STANDS WITH WHEELS

P1801	For all Soprano and Alto Diatonic Metallophones and Xylophones	\$429.95 \$365.46
P1802	For Bass Diatonic Metallophones and Xylophones	\$489.95 \$416.46
† P1803	For all Soprano and Alto Chromatic Metallophones and Xylophones	\$529.95 \$450.46
† P1804	For Bass Chromatic Metallophones and Xylophones	\$599.95 \$509.96

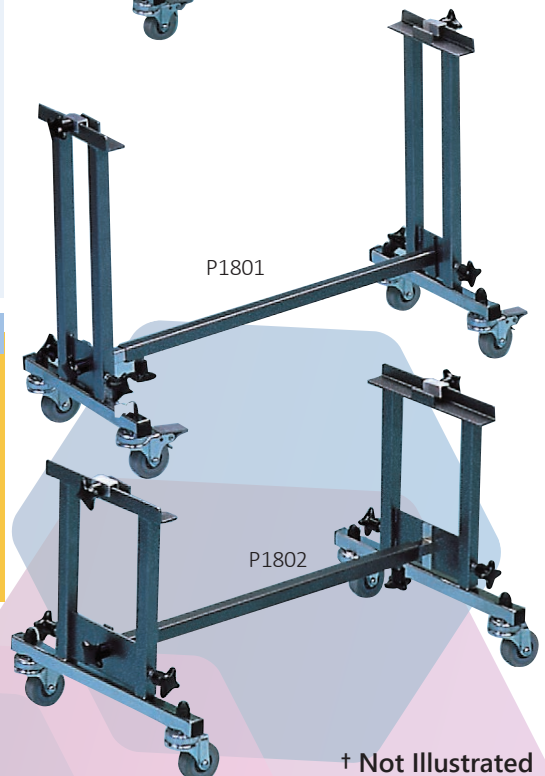

P1801

P1802

† Not Illustrated



Educator or Educational institution status is required for discounted pricing featured in this catalog.



BERGERAULT® ORFF INSTRUMENT SETS

FIVE ORFF INSTRUMENT SET

Rosewood Bar

† P1904	\$3,209.75....	\$2,728.30
Soprano Xylophone		P1101
1 Alto Xylophone		P1111
1 Soprano Glockenspiel		P1201
1 Alto Glockenspiel		P1211
1 Alto Metallophone		P1311

Techlon Bar

† P1904C	\$3,209.75....	\$2,814.80
1 Soprano Xylophone		P1101C
1 Alto Xylophone		P1111C
1 Soprano Glockenspiel		P1201
1 Alto Glockenspiel		P1211
1 Alto Metallophone		P1311

THREE ORFF INSTRUMENTS TO START

Rosewood Bar

† P1903	\$1,479.85....	\$1,257.88
1 Alto Xylophone		P1111
1 Soprano Glockenspiel		P1201
1 Alto Glockenspiel		P1211

Techlon Bar

† P1903C	\$1,479.85....	\$1,307.38
1 Alto Xylophone		P1111C
1 Soprano Glockenspiel		P1201
1 Alto Glockenspiel		P1211

† Not Illustrated

SEVEN ORFF INSTRUMENT SET

Rosewood Bar

P1905	\$7,209.65....	\$6,128.22
1 Soprano Xylophone		P1101
2 Alto Xylophones		P1111
1 Bass Xylophone		P1121
1 Soprano Glockenspiel		P1201
1 Alto Glockenspiel		P1211
1 Alto Metallophone		P1311

Techlon Bar

† P1905C	\$7,209.65....	\$6,414.72
1 Soprano Xylophone		P1101C
2 Alto Xylophones		P1111C
1 Bass Xylophone		P1121C
1 Soprano Glockenspiel		P1201
1 Alto Glockenspiel		P1211
1 Alto Metallophone		P1311



GUIDE TO SELECTING INSTRUMENTS

It is an exciting time for teachers just starting out with Orff instruments or programs! We know how overwhelming buying new instruments for your classroom can be and therefore we offer this guide on what to consider when buying for your music program.

Types of Instruments: The Orff Instrumentarium consists of three different timbres- glockenspiels, metallophones, and xylophones; and three ranges of voice- soprano, alto and bass.

Sound: As diversity of sound is important, we suggest starting with at least one of each timbre. Metal instruments tend to overshadow wood in tonal volume, so it is wise to have more xylophones than metallophones. Alto and soprano instruments are economical and are the initial foundation of Orff sound. Bass xylophones make an excellent and important addition and are strongly recommended as an early purchase. Sub-contra and contra bass bars have true pitch and rich tones that make them excellent timpani replacements.

Building A Music Classroom: Financial limitations often make the process of building your classroom instrumentation take time, even several years. Be assured when you buy a Bergerault® Orff Instrument, you are buying an instrument that will remain in perfect condition and tune, and make adding new instruments a breeze. All Bergerault® Instruments will combine easily with others tuned to A440.

We know budget will always factor in your choice of instrument purchase and therefore we strive to provide the highest quality and the lowest possible price. Buying top quality instruments assures the life of the instrument for years to come.

Please contact our knowledgeable staff at 1-800-443-3592 for consultation and assistance.

EIGHT ORFF INSTRUMENTARIUM SET

Rosewood Bar

† P1906 ~~\$7,959.60~~..... **\$6,765.68**

1 Soprano Xylophone	P1101	1 Alto Glockenspiel	P1211
1 Alto Xylophone	P1111	1 Soprano Metallophone	P1301
1 Bass Xylophone	P1121	1 Alto Metallophone	P1311
1 Soprano Glockenspiel	P1201	1 Bass Metallophone	P1321

Techlon Bar

† P1906C ~~\$7,959.60~~..... **\$6,952.18**

1 Soprano Xylophone	P1101C	1 Alto Glockenspiel	P1211
1 Alto Xylophone	P1111C	1 Soprano Metallophone	P1301
1 Bass Xylophone	P1121C	1 Alto Metallophone	P1311
1 Soprano Glockenspiel	P1201	1 Bass Metallophone	P1321

Classroom sets include Wide Bar Glockenspiels. Should Classic Glockenspiels be preferred, please specify when ordering.

BALANCED CLASSROOM ORFF INSTRUMENTARIUM SET

Rosewood Bar Xylophones & Contra Bass Bars

† P1910 ~~\$17,848.85~~..... **\$15,100.58**

3 Soprano Xylophones	P1101	2 Alto Metallophones	P1311
4 Alto Xylophones	P1111	1 Bass Metallophone	P1321
2 Bass Xylophones	P1121	1 Sub-Contra Bass Bar C	P1401
2 Soprano Glockenspiels	P1201	1 Contra Bass Bar F	P1404
2 Alto Glockenspiels	P1211	1 Contra Bass Bar G	P1405
1 Soprano Metallophone	P1301	3 Contra Bass Mallets	P2520

Techlon Bar Xylophones & Contra Bass Bars

† P1910C ~~\$17,848.85~~..... **\$15,700.58**

3 Soprano Xylophones	P1101C	2 Alto Metallophones	P1311
4 Alto Xylophones	P1111C	1 Bass Metallophone	P1321
2 Bass Xylophones	P1121C	1 Sub-Contra Bass Bar C	P1401C
2 Soprano Glockenspiels	P1201	1 Contra Bass Bar F	P1404C
2 Alto Glockenspiels	P1211	1 Contra Bass Bar G	P1405C
1 Soprano Metallophone	P1301	3 Contra Bass Mallets	P2520

† Not Illustrated

CONTRA BASS BARS

BASIC SET OF THREE BARS

Rosewood Bar

P1907 ~~\$1,879.70~~..... **\$1,594.76**

P1401	C
P1404	F
P1405	G
3 P2520	Contra Bass Mallets

Techlon Bar

† P1907C ~~\$1,879.70~~..... **\$1,685.76**

P1401C	C
P1404C	F
P1405C	G
3 P2520	Contra Bass Mallets

SUPPLEMENTARY SET

Rosewood Bar

† P1908 ~~\$2,019.70~~... **\$1,713.76**

P1402	D
P1403	E
P1406	A
2 P2520	Contra Bass Mallets

Techlon Bar

† P1908C ~~\$2,019.70~~... **\$1,811.76**

P1402C	D
P1403C	E
P1406C	A
2 P2520	Contra Bass Mallets

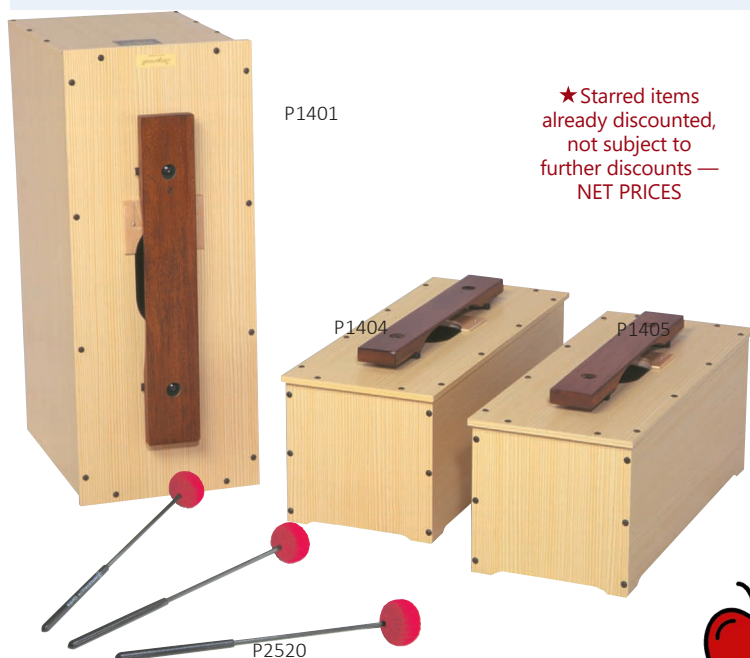

★ Starred items already discounted, not subject to further discounts — NET PRICES

OCTAVE SET OF BASS BARS

Rosewood Bar

† P1909 ~~\$5,069.10~~... **\$4,298.78**

P1401	C
P1402 †	D
P1403 †	E
P1404	F
P1405	G
P1406 †	A
P1407 †	B
P1408 †	Hi C
8 P2520	Contra Bass Mallets

Techlon Bar

† P1909C ~~\$5,069.10~~... **\$4,542.28**

P1401C	C
P1402C	D
P1403C	E
P1404C	F
P1405C	G
P1406C	A
P1407C	B
P1408C	Hi C
8 P2520	Contra Bass Mallets



Educator or Educational institution status is required for discounted pricing featured in this catalog.

Peripole® Halo® Gold Recorder

Still The Best Classroom Recorder Made!

- Smooth, even tone with accurate tuning and intonation!
- Superior Sound!
- Complete Enrichment Kit Included!

EXCLUSIVELY FROM PERIPOLE



Recorder Features:

- Two piece, Renaissance shape with textured ABS construction. Looks and feels like a wooden instrument.
- Curved windway for optimal sound.
- Easy to produce low notes without shrieks or squeaks.
- Includes Enrichment Kit.

Enrichment Kit Contents:

- ▶ **Peripole® Halo® Hanger Neck Strap** –
 - Holds recorder in true vertical ready-to-play position.
 - Won't slide up and interfere with thumb position or windway.
 - Includes **Safety-Snap®** breakaway unit.
- ▶ **Extra-Wide zippered case** designed to hold recorder with **Halo®** neck strap attached.
- ▶ Stick-On Velcro **Thumb Spot** to help position the right thumb.
- ▶ Online access to **Peripole® Fingering Chart** with printing/photocopy permission at peripole.com.
- ▶ Cork grease and cleaning rod included.

P6000	SOPRANO	\$7.95	\$5.95
BAROQUE FINGERING			
P6001	SOPRANO	\$7.95	\$5.95
GERMAN FINGERING			
P6250	ALTO	\$19.95	\$15.96
BAROQUE FINGERING			
P6251	ALTO	\$19.95	\$15.96
GERMAN FINGERING			

* Easy To Sanitize!



★ Starred items already discounted, not subject to further discounts. NET PRICES



SOPRANO
P6000, P6001

ALTO
P6250, P6251

Educator or Educational institution status is required for discounted pricing featured in this catalog.

Register for educator account at Peripole.com or contact us for educator discounts.

Additional Special School Discounts Available!

Peripole® Halo® Recorders and Halo® Hangers are Protected by Trademark and Trade Dress

TRADITIONAL CONSORT RECORDERS

P6101 ONE PIECE SOPRANO RECORDER BAROQUE FINGERING \$3.25..... **\$2.95**
 †**P6102 ONE PIECE SOPRANO RECORDER GERMAN FINGERING** \$3.25..... **\$2.95**
 This superior quality one piece baroque recorder comes with bag, cleaning rod, and fingering chart. Key of C.

6103 THREE PIECE SOPRANO RECORDER BAROQUE FINGERING \$6.95... **\$5.50**
 †**6104 THREE PIECE SOPRANO RECORDER GERMAN FINGERING** \$6.95... **\$5.50**
 This three piece deluxe recorder delivers clear high notes. Comes with zippered case, cleaning rod, joint grease, and fingering chart. Key of C.

P6200 GARKLEIN ONE PIECE RECORDER \$15.95..... **\$12.76**
 Smallest recorder available. Carrying case included. Key of C.

P6150 SOPRANINO RECORDER BAROQUE FINGERING \$7.95..... **\$6.50**
 Smaller than soprano with a piccolo voice. Carrying case included. Key of F.

†**P6255 ALTO RECORDER BAROQUE FINGERING** \$17.99..... **\$14.39**
 †**P6256 ALTO RECORDER GERMAN FINGERING** \$17.99..... **\$14.39**
 Includes case, cleaning rod and joint grease. Key of F.

P6300 TENOR RECORDER \$60.00..... **\$48.00**
 Carrying case included. Key of C.

P6400 BASS RECORDER \$189.00..... **\$151.20**
 Carrying case included. Key of F.

†**P6450 FULL RECORDER CONSORT** \$250.00..... **\$200.00**
 Full Recorder Consort includes soprano, alto, tenor, and bass traditional baroque recorders in an easy to pack carrying case.



NEW GERMAN ALTO!

* Easy To Sanitize!

NEW!



WHOLE NOTE® HANGERS

These recorder neck-straps are made with a resilient synthetic rubber (latex free) "O" ring, reminiscent of a "whole note." Value-priced, neck straps feature the Peripole® Safety-Snap® Breakaway unit for ultimate safety. The Whole Note® Hanger fits the P6101, One Piece Recorder, the P6103, Three Piece Recorder, the P6150 Sopranino, and P6200 Garklien.

P6010 WHOLE NOTE® HANGER \$1.25.... **\$1.00**

MUTEFLUTE Recorder Practice Mute

A simple, economical, and practical solution for sound reduction when practicing and encourages proper air flow. Can be inserted into the recorder to either partially or fully mute the sound.

- P6011 SINGLE****\$1.00★**
- P6012 12 PACK****\$9.95★**
- P6024 24 PACK** ...**\$18.95★**

!
 The musical instruments in our catalog are not toys. They are intended for use by adults and children with adult supervision. Unless otherwise stated, the instruments are not recommended for children under 3 years of age.

Peripole® Halo® Hanger EXCLUSIVELY FROM PERIPOLE

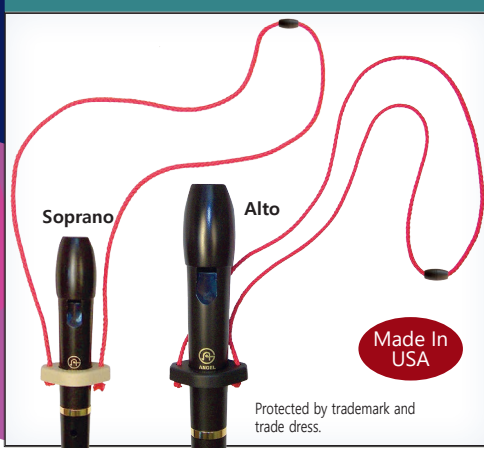

Only the Halo® Hanger Has:

- 2 point suspension
- True vertical positioning
- No interference with thumb hole or windway
- Protected by Trademark and Trade Dress

Replacement Halo® Hanger Now Available!

- P6009 SOPRANO HALO® HANGER** \$1.95..... **\$1.56**
 Designed to fit P6000, P6001
- P6257 ALTO HALO® HANGER****\$2.50★**

Peripole® Safety-Snap® Breakaway Unit

Now On All Halo® and Whole Note® Hangers.

The Best Sounding Classroom Recorder, With The Best Neck Strap, is now the Safest!



Superior Safety

See page 74-77 for complete list of Recorder Publications

UNIQUE WIND TONES



P6080

- Acts as a bridge instrument between recorder and band, teaching essential skills needed for more advanced band instruments without struggle.
- Can bring a whole new sound to the recorder ensemble!
- In the key of C.
- Silicone keys are great for adaptive learning and small hands.

NUVO PRE-BAND INSTRUMENTS

- P6070 NUVO Dood**\$35.99★
 With it's mellow clarinet-like sound, the Dood is a great way to introduce single reed skills prior to band. With it's recorder-like fingering in the key of C, it makes a great addition to any recorder ensemble. 100% waterproof for easy sanitization.
 * Easy To Sanitize!
- P6080 NUVO Toot**\$35.99★
 The next step between recorder and flute! Nuvo Toot utilizes it's unique Firstnote lip plate to get kids playing fast and help teach positioning, fingering and breath control before moving on to the traditional included flute lip plate.
 * Easy To Sanitize!

NUVO RECORDER+

Nuvo Recorder+ utilizes a unique silicone key system and adjustable thumb rest for better adaptive learning! Great alternative for students who struggle with traditional recorder. Standard Baroque or German recorder fingering in the key of C major. 100% waterproof for easy cleanability.

NUVO SOPRANO RECORDER+

- P6060 Baroque Black Recorder w/Blue Keys**\$17.99★
P6061 Baroque Black Recorder w/Green Keys\$17.99★
P6062 Baroque Black Recorder w/Pink Keys\$17.99★
- P6063 German White Recorder w/Blue Keys**\$17.99★
P6064 German White Recorder w/Green Keys\$17.99★
P6065 German White Recorder w/Pink Keys\$17.99★



* Easy To Sanitize!

MELODIONS

- P6852 Starter Alto Melodion** \$29.99..... \$23.99
P6850 Alto Melodion \$69.99..... \$55.99
P6851 Deluxe Alto Melodion \$109.99..... \$87.99



NEW

Colors may vary depending on availability.



P6850



P6851

DIDGERIDOOS

- Lightweight PVC construction
- Extremely durable
- Produce unbelievable tonal qualities

* Easy To Sanitize!

- P6702 Straight - 3" x 51", Traditional artwork**\$39.99★
P6706 Curved 3"x 50", Traditional artwork\$43.95★
P6707 Green swirl design with large bell 56"\$54.95★
P6708 Orange swirl design 49"\$39.99★



DRUM MAJOR WHISTLE

- P4328**\$16.95★
 Useful in Samba, West African music, musical games, or marching bands.



SLIDE WHISTLES

- P6500 Metal Slide Whistle** \$24.95... \$19.96
P6501 Plastic Slide Whistle ...\$5.00★



Colors may vary.

STERISOL LIQUID

Sterilizing liquid for recorders, didgeridoos, and other mouthpiece instruments

- P6051 Sterisol 8 oz Pump Spray**\$6.50★
 † **P6052 2 oz Concentrate Makes one quart**\$5.50★
 † **P6053 8 oz Concentrate Makes one gallon**\$8.50★



★ Starred items already discounted, not subject to further discounts — NET PRICES

MALLETS

Our ORFF Mallets are Made in the USA



P2501	All Purpose Wood Mallets, pair\$2.50★
P2502	Double-Headed Wood Mallet, each\$2.50★
P2504	Medium Rubber Resonator Bell Mallets, pair	\$4.50..... \$3.60
P2507	Wound Mallets for Soprano Orff Instruments, pair	\$24.95..... \$19.96
P2507B	Birch shaft Wound Mallets for Soprano Orff Instruments, pair	\$24.95..... \$19.96
P2508	Wound Mallets for Alto Orff Instruments, pair	\$24.95..... \$19.96
P2508B	Birch shaft Wound Mallets for Alto Orff Instruments, pair	\$24.95..... \$19.96
P2509	Wound Mallets for Bass Orff Instruments, pair	\$24.95..... \$19.96
P2509B	Birch shaft Wound Mallets for Bass Orff Instruments, pair	\$24.95..... \$19.96
P2510	Large Wound Percussion Mallet, each	\$14.95..... \$11.96
P2512	Medium Temple Block Mallets, pair	\$14.95..... \$11.96
P2513	Hard Temple Block Mallets, pair	\$14.95..... \$11.96
P2518	Wood Mallets for Soprano Glockenspiels, nylon shaft, pair	\$12.95..... \$10.36
P2519	Rubber Mallets for Alto Glockenspiels, nylon shaft, pair	\$16.95..... \$13.56
P2520	Contra Bass Wound Mallet, each	\$19.95..... \$15.96
P2530	Yellow Bells Mallets, soft rubber head, pair\$3.00★
P2531	Red Bell Mallets, medium rubber head, pair\$3.00★
P2534	Economy Orff Mallets, soft blue rubber, pair	\$3.95..... \$3.16
P2535	Economy Orff Mallets, hard red rubber, pair	\$3.95..... \$3.16

2600	Hard Rubber Orff Mallets, wood shaft, pair	\$9.95..... \$7.96
P2536	Medium Rubber Orff Mallets, wood shaft, pair	\$9.95..... \$7.96
P2539	Rubber Contra Bass Mallet, wood shaft, each	\$12.95..... \$10.36
P2540	Cymbal Brushes, pair\$19.95★
P2543	Professional Cowbell Beater\$18.99★
P2544	Drum Sticks, nylon tip, pair	\$9.95..... \$7.96
P2546	Drum Sticks, wood tip, pair	\$9.95..... \$7.96
P2552	Small Sabian Gong Mallet, 19.25" shaft with 3.75" top\$68.49★
P2553	Large Sabian Gong Mallet, 19.5" shaft with 4.25" top\$73.99★
P2560	LP Tamborim Striker\$14.99★
P2565	LP Surdo Mallet, each\$49.99★
P2600	Toca Bass Percussion Mallet Kente, pair\$18.99★
P2601	Toca Bass Percussion Mallet Purple Glow, pair\$18.99★
P8204	Dun Dun sticks, pair\$9.60★
P2525	ORFF INSTRUMENTARIUM EXPLORATION Mallet KIT	\$139.95..... \$111.96

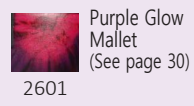

A GUIDE TO ORFF MALLETS – FIBERGLASS VS BIRCH SHAFTS

Peripole, Inc. is pleased to offer quality Wound Orff Instrument Mallets in two shaft materials: fiberglass—which comes with purchase of our diatonic and complete chromatic instruments, and birch hardwood. Both materials have advantages and disadvantages that can factor in when choosing one for your classroom.

Fiberglass is extremely durable and break resistant. It has heavier head balance, which creates a feeling of "bouncing a ball" when playing. Many teachers and clinicians prefer and recommend this kind of balance. If mallet shafts are struck too forcefully against a hard surface, the protective coating on the shaft can eventually chip and expose fiberglass which can splinter.

Mallets can be repaired by covering or refinishing the damaged portion or replacement of the mallet.

Birch Hardwood is a thicker, lighter material and creates a larger ergonomic grip and balanced feel. It is quite durable with normal use, however can be broken if stepped on or severely abused. If the shaft is struck too hard it will create visible imperfections in the wood. Luckily these are easy to repair by sanding and painting or covering.

Nylon is a splinter-free material and remains so even after extended use. It is more flexible than desired for longer mallets but is optimal for shorter ones. We now use nylon for all glockenspiel mallets.



Educator or Educational institution status is required for discounted pricing featured in this catalog.

PERIPOLE® RAINBOW® HAND DRUMS

Featuring exclusive products made by leading manufacturers of percussion instruments uniquely designed for music education.

THE ORIGINAL



PERIPOLE® RAINBOW® HAND DRUMS



P4918RN

NEW!

DRUM SETS

P4917 Set of Three Rainbow® Drums W/ Notches (Green, Yellow, Red)

~~\$119.99~~..... **\$95.99**

P4918N Set of Five Natural wood Finish, w/ case, no thumb notches

~~\$119.99~~..... **\$95.99**

P4918NN Set of Five Natural wood Finish, w/ case and thumb notches

~~\$149.99~~..... **\$119.99**

P4918RN Set of Five Rainbow® Finish, w/case and thumb notches

~~\$169.99~~..... **\$135.99**



P4918RN

SPECIFICATIONS

- 2 1/2" deep non-tunable finest quality maple shells
- All-climate synthetic heads
- Free of lead based paints

INDIVIDUAL DRUMS

RAINBOW® COLORS DRUMS

P4908RN	8" Purple Drum W/Notch	\$27.00 \$21.60
P4910RN	10" Blue Drum W/Notch	\$32.00 \$25.60
P4912RN	12" Green Drum W/Notch	\$37.00 \$29.60
P4914RN	14" Yellow Drum W/Notch	\$42.00 \$33.60
P4916RN	16" Red Drum W/Notch	\$47.00 \$37.60

NATURAL WOOD

P4908N	8" Natural Drum	\$20.00 \$16.00
P4908NN	8" Natural Drum W/Notch	\$20.00 \$16.00
P4910N	10" Natural Drum	\$25.00 \$20.00
P4910NN	10" Natural Drum W/Notch	\$25.00 \$20.00
P4912N	12" Natural Drum	\$30.00 \$24.00
P4912NN	12" Natural Drum W/Notch	\$30.00 \$24.00
P4914N	14" Natural Drum	\$35.00 \$28.00
4914NN	14" Natural Drum W/Notch	\$35.00 \$28.00
P4916N	16" Natural Drum	\$40.00 \$32.00
P4916NN	16" Natural Drum W/Notch	\$40.00 \$32.00



Newly redesigned Peripole® Rainbow® Hand Drums come with thumb notches for traditional technique. Solid wood shells and synthetic skins combine for great tones.

Rainbow colors coordinate with the frequencies of the electromagnetic spectrum to reinforce science lessons with red being lowest pitch (lowest vibration) and Violet being highest pitch (highest vibration). Available individually or in a set of 5 with carrying case and shoulder strap. Also available in natural color.

Register for educator account at Peripole.com



Educator or Educational institution status is required for discounted pricing featured in this catalog.

WORLD PERCUSSION DESIGNED FOR SCHOOLS AND GROUPS

- Genuine ethnic drum styles
- Designed to be played in a seated position without the need to lift or tilt

- Solid wood construction
- Natural skin heads
- No need to purchase separate stand

See Percussion Packages on pages 36-37



SIENTA® CONGAS

P4150	Quinto – 9" x 28"	\$289.95.....	\$231.96
P4151	Conga – 10" x 28"	\$319.95.....	\$255.96
P4152	Tumba – 11" x 28"	\$349.95.....	\$279.96

CONGA SPECIFICATIONS

- Sturdy chromed steel legs raise drum off the ground for maximum tonal response
- Finest quality natural skin heads
- Easy-to-use key tuning
- Seasoned Asian oak hardwood
- EasyPlay style hoops for playing comfort



TYCOON NGOMA LEADER DRUMS

P4305	Kente w/Sound Arches\$550.00★
P4306	Dark Wood w/Cross Stand\$550.00★

- 13.5" x 42"
- Constructed of environmentally-friendly Siam oak wood
- Premium quality goat skin head
- 5mm non-stretch rope in Mali weave for easy and long-lasting tuning

- Kente drum features sound arches for maximum tonal response
- Dark wood drum features cross stand for easy play and sound resonance

IQ SMALL NGOMA DRUM

P4307\$140.00★
-------	----------------

- 11" x 27.25"
- Ideal for world rhythms
- Designed for seated or standing play without need for tilting the drum or a stand
- Great for music class, drum circles, music therapy and ensembles!



DJEMBE CARRYING CASES/PACKS AVAILABLE—SEE PAGE 33

P4131

KEY-TUNED SIENTA® DJEMBE

P4131	\$399.95.....	\$319.96
Tree-Bark™ Wood Finish – 12" x 26"		

KEY-TUNED DJEMBE SPECIFICATIONS

- Finest quality natural skin heads
- Easy-to-use key tuning
- Sound arches for maximum tonal response
- Natural Grain or Tree-Bark texture
- Carved from a single piece of plantation-grown (non-rainforest) mahogany



P4307

P4306



TOCA SYMPATICO NESTING DRUMS

Toca Nesting Drums are unique PVC drums with durable synthetic heads that can be removed and played like a frame drum! Nesting feature makes them ideal for storage and travel!



TOCA SYMPATICO NESTING DJEMBE

Drum sizes 8", 10", and 12" available individually or in a set of 3 in Purple Glow or Kente finish.

- †P4260 8" Kente Nesting Djembe\$99.99★
- P4261 8" Purple Glow Nesting Djembe\$99.99★
- †P4262 10" Kente Nesting Djembe\$149.99★
- P4263 10" Purple Glow Nesting Djembe\$149.99★
- †P4264 12" Kente Nesting Djembe\$169.99★
- P4265 12" Purple Glow Nesting Djembe\$169.99★
- †P4266 3 Piece Kente Nesting Djembe Set\$369.99★
- P4267 3 Piece Purple Glow Nesting Djembe Set\$369.99★



TOCA SYMPATICO NESTING BASS DRUMS

Drum sizes 12", 14", and 16" available individually or in a set of 3 in Purple Glow or Kente finish. Comes with a single mallet per drum.

- P4270 12" Kente Nesting Bass Drum\$219.99★
- †P4271 12" Purple Glow Nesting Bass Drum\$219.99★
- P4272 14" Kente Nesting Bass Drum\$289.99★
- †P4273 14" Purple Glow Nesting Bass Drum\$289.99★
- P4274 16" Kente Nesting Bass Drum\$349.99★
- †P4275 16" Purple Glow Nesting Bass Drum\$349.99★
- P4276 3 Piece Nesting Bass Drums, Kente\$799.99★
- †P4277 3 Piece Nesting Bass Drums, Purple Glow\$799.99★



P2600\$18.99★
Toca Bass Percussion Mallet Kente, pair

P2601\$18.99★
Toca Bass Percussion Mallet Purple Glow, pair



TOCA SYMPATICO TUBADORA DRUMS

The newest innovation from Toca! Toca's innovative Freestyle Tubadora drums now come as a floor drum model with tunable heads!

- Light weight & durable PVC body
- Tunable heads can be removed and played as hand drums
- Sound arches for easy seated play without need for a stand or tilt



TOCA FREESTYLE BONGOS

- P4280 Kente Freestyle Bongos\$48.99★
- P4281 Purple Glow Freestyle Bongo\$48.99★
- †P4282 Red Freestyle Bongo\$48.99★
- †P4283 Blue Freestyle Bongo\$48.99★
- †P4284 Green Freestyle Bongo\$48.99★
- †P4285 Violet Freestyle Bongo\$48.99★



- P4210 10" Kente Tubadora Floor Drum\$199.99★
- †P4211 10" Purple Glow Tubadora Floor Drum\$199.99★
- P4212 12" Kente Tubadora Floor Drum\$229.99★
- †P4213 12" Purple Glow Tubadora Floor Drum\$229.99★
- †P4214 14" Kente Tubadora Floor Drum\$269.99★
- †P4215 14" Purple Glow Tubadora Floor Drum\$269.99★

Register for educator account at Peripole.com

† Not Illustrated

TOCA FREESTYLE DJEMBES



FREESTYLE AND FREESTYLE II DJEMBES

- Natural goatskin head (Freestyle models)
- Weather-resistant synthetic head (Freestyle II models)
- Brightly colored synthetic shell
- Traditional rim
- Easy to use key tuning - key included
- Protective rubber rim on bottom
- 14" model includes matching colored carrying bag

† Not Illustrated

★ Starred items already discounted, not subject to further discounts — NET PRICES

TOCA FREESTYLE DJEMBES - NATURAL SKIN HEAD

P4390	14" Fiesta Orange, 24" Height w/bag\$249.99★
† P4391K	14" Kente, 24" Height w/bag\$249.99★
† P4392	12" Fiesta Orange, 22" Height\$189.99★
† P4393K	12" Kente, 22" Height\$189.99★
P4394	10" Fiesta Orange, 20" Height\$149.99★
† P4395K	10" Kente, 20" Height\$149.99★

TOCA FREESTYLE II DJEMBES - SYNTHETIC HEAD

† P4380RM	14" Red Mask, 24" Height w/bag\$289.99★
† P4380SC	14" Spun Copper, 24" Height w/bag\$289.99★
† P4381RM	12" Red Mask, 22" Height\$199.99★
† P4381SC	12" Spun Copper, 22" Height\$199.99★
† P4382RM	10" Red Mask, 20" Height\$149.99★
† P4382SC	10" Spun Copper, 20" Height\$149.99★



RED MASK

KENTE

SPUN COPPER



P4163

P4165

P4164

P4160

P4162

P4161

P4166

TOCA FREESTYLE COLORSOUND™ DJEMBES

P4160	Red Colorsound™ Djembe\$49.99★
P4161	Orange Colorsound™ Djembe\$49.99★
P4162	White Colorsound™ Djembe\$49.99★
P4163	Green Colorsound™ Djembe\$49.99★
P4164	Blue Colorsound™ Djembe\$49.99★
P4165	Indigo Colorsound™ Djembe\$49.99★
P4166	Violet Colorsound™ Djembe\$49.99★
P4167	Set of 7 Rainbow Colors\$319.99★

- Traditional rope tuning
- Rainbow colors
- 7" head x 12½" tall
- Synthetic shells and heads



P4174

P4173

P4171

P4175

P4170

P4172

TOCA FREESTYLE COLORSOUND™ NON-TUNABLE DOUMBES

P4170	Kente Colorsound™ Doumbek\$32.99★
P4171	Blue Colorsound™ Doumbek\$32.99★
P4172	Red Colorsound™ Doumbek\$32.99★
P4173	Green Colorsound™ Doumbek\$32.99★
P4174	Indigo Colorsound™ Doumbek\$32.99★
P4175	Purple Glow Colorsound™ Doumbek\$32.99★

- 7" head x 10½" tall
- Rainbow colors
- Synthetic shells and heads



The musical instruments in our catalog are not toys. They are intended for use by adults and children with adult supervision. Unless otherwise stated, the instruments are not recommended for children under 3 years of age.



Educator or Educational institution status is required for discounted pricing featured in this catalog.

THE MANDÉ INSTRUMENT ENSEMBLE

HARDWOOD ROPE TUNED DJEMBES

Hand carved from one piece of environmentally-friendly, plantation grown Mahogany wood. Kiln dried shell with 20 coats of teak oil to protect and preserve the wood. Hand selected goatskin heads, with authentic rope tuning. Available in 8", 10", and 12"



P4423

† P4450	8" HARD WOOD DJEMBE\$109.99★
† P4451	10" HARD WOOD DJEMBE\$149.99★
P4452	12" HARD WOOD DJEMBE\$199.99★

DUNDUN BASS DRUMS

Made from durable, sustainably-harvested Siam oak wood, the traditional shell shape of this drum provides the most authentic African sound. It features a triple-ring mounting system and 5mm non-stretch rope for long-lasting tuning. Sticks are included.

P4121	10" KENKENI- SMALL DUNDUN\$299.99★
P4122	12" SANGBAN- MEDIUM DUNDUN\$369.99★
P4123	15" DUNDUNBA- LARGE DUNDUN\$499.99★
P4124	20" BANBATA XLARGE DUNDUN\$779.99★



P4121

P4122

P4123

P4124

TOCA KSING KSING (SINGLE)

P4323\$14.99★

Ksing Ksing - The ksing ksing (kah-SING kah-SING) also called "sese-sese" (SE-say, SE-say) in some areas, are metal "ears" with attached metal rings that are sometimes attached to a soloist's or leader's drum to produce a rattle effect.

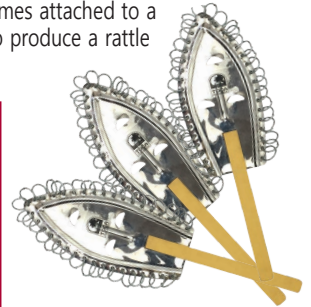

P4323



The musical instruments in our catalog are not toys. They are intended for use by adults and children with adult supervision. Unless otherwise stated, the instruments are not recommended for children under 3 years of age.

TYCOON DUNDUN BELLS

† P4318	Kenkeni- Small Bell	\$39.00 \$31.20
P4319	Sangban- Medium Bell	\$44.00 \$35.20
† P4320	Dundunba- Large Bell	\$49.00 \$39.20
† P4321	3 Bell Set	\$129.99 \$103.99

- Crafted from heavy duty steel
- Use the clamp to attach the bell to a rack mount when playing dun-duns in a vertical, upright position.
- Wingnut and bolt assembly can be removed to insert the bell through the ropes when playing dun-duns in a horizontal, sideways position
- Metal striker included



P4319

† Not Illustrated



★ Starred items already discounted, not subject to further discounts — NET PRICES

DUNDUN FLOOR STAND

P4111	Kenkeni small Dundun Floor Stand	\$27.95 \$22.36
P4112	Sangban Med Dundun Floor Stand	\$27.95 \$22.36
P4113	Dundunba Large Dundun Floor Stand	\$27.95 \$22.36
P4114	Bambata XLarge Dundun Floor Stand	\$37.95 \$30.36



DUNDUN FOLDING CROSS STAND

P4115	Kenkeni Small Dundun Folding Cross Stand\$74.99★
P4116	Sangban Med Dundun Folding Cross Stand\$79.99★
P4117	Dundunba Large Dundun Folding Cross Stand\$84.99★
P4118	Bambata XLarge Dundun Folding Cross Stand\$99.99★



DOUMBEKS/DARBUKAS

★ Starred items already discounted, not subject to further discounts — NET PRICES

TYCOON EGYPTIAN ORNATE DOUMBEK

P4981\$329.95★

- Well-rounded bass to crisp higher pitches
- Shell constructed from Turkish copper and hand painted by highly skilled artisans
- Equipped with a durable, tunable synthetic head
- Tuning key included

P4981



TYCOON ALUMINUM DOUMBEK

P4980\$199.99★

- Wide spectrum of sounds, from a well-rounded bass to crisp higher pitches
- Aluminum shell hand hammered by skilled craftsmen
- Equipped with a durable, tunable synthetic head
- Tuning key included

P4980



ROPE TUNED ASHIKO DRUMS

- P4345** 19" TALL, 8" DIAMETER HEAD ASHIKO DRUM\$179.99★
- P4346** 22-1/2" TALL, 10" DIAMETER HEAD ASHIKO DRUM\$214.99★
- P4347** 25" TALL, 12" DIAMETER HEAD ASHIKO DRUM\$294.99★

Constructed of hand-selected environmentally-friendly Siam Oak wood, this ashiko is made with hand-picked premium goat skin. The 5mm extra strong non-stretch rope allows for easy and lasting tuning.

P4347

P4346

P4345



TALKING DRUM

P4370\$139.95★

The Talking Drum derives its name from its ability to change pitch by squeezing its exterior rope framework. As the player squeezes the rope, the tension on the head increases, thus raising the pitch. Made of durable, light-weight hardwood with two natural skin heads. Stretch resistant rope. **Quality Construction. Mallet included.**



P4370

AFRICAN CAXIXI SHAKERS

Hand-woven baskets with durable plastic bottoms, filled with loose beads. Mahogany shellac finish for durability. Handles.

- P5511** Small Caxixi\$24.99★
- P5512** Large Caxixi\$26.99★

P5512



P5511

See page 36-37 for full Mande Ensemble sets



Educator or Educational institution status is required for discounted pricing featured in this catalog.

GHANAIAN CAXIXI P4327 \$13.50..... \$10.80

Consisting of a closed basket with a flat bottom traditionally cut from dried gourd and filled with seeds or rocks, caxixi are a traditional shaker instrument in African as well as Brazil and Cuban music. Usually played in pairs.

Colors and designs will vary.



P4327



SOUTH AMERICAN AND CARIBBEAN DRUMS



P4480 ★ Starred items already discounted, not subject to further discounts — NET PRICES

- 6" Head, 1 3/4" deep shell, 10 tuning lugs
- Hardwood shell construction with rounded bottom
- Black synthetic head
- Tamborim striker sold separately

LP TAMBORIM
P4480 LP Deluxe Wood Tamborim\$94.99★

A small round Brazilian frame drum of Portuguese and African descent, today they are commonly used in Samba, Pagode and Bossa Nova music. With a high sharp timbre and short sustain.

LP TAMBORIM STRIKER
P2560 Tamborim striker\$14.99★



P2560

★ Starred items already discounted, not subject to further discounts — NET PRICES

LP SURDO Mallet
P2565\$49.99★



P2565

SURDO/GENERIC PERCUSSION STRAP
†P2566\$19.99★

WORLD BEAT PLENERA DRUMS- SET OF 3
P4416\$119.99★

- Set of three drums: 8", 10" and 12"
- Sturdy PVC Shells and tunable natural skin heads
- Includes nylon bag and tuning wrench



P4416

★ Starred items already discounted, not subject to further discounts — NET PRICES

LP MERENGUE GUIRA
P4956\$119.99★

An essential element, along with the tambora (pg 30), for playing Merengue Music. Professional quality from LP Percussion.



P4956

LP SURDO
P4482 LP 22"x20" wood surdo\$529.99★

- LP's Wood Surdo produces a thunderous, warm tone that provides the bass notes essential to Samba music.
- 22"H x 20"D
 - Hardwood shell construction
 - Specially designed overtone controlling synthetic heads
 - 10 single-tension drum key tuning lugs
 - Height adjusting legs with rubber feet

Often played in Samba ensembles with Tamborim.



P4482

Register for educator account at Peripole.com

Educator or Educational institution status is required for discounted pricing featured in this catalog.

CAJONS



LOUSON DRUMS CAJONTAB: Great for the Percussionist on the go! Lightweight and portable, Cajon Tab® is an excellent choice for teachers in a busy classroom. With easy to adjust outside snare, sound hole covers that can change volume and tone, and attachable strap, this Cajon can be customized to fit in with any music program!

CAJON TAB® PORTABLE CAJON
 † P4400 10" CAJON TAB®\$189.00★
 P4401 12" CAJON TAB®\$219.00★



CAJON TAB® BONGO WITH CASTANETS
 P4403\$279.00★



- 2 chambers, each with its own adjustable sound hole
- Includes removable snare, and "castanet" attachments
- Black removable strap allows for easy and portable play while standing or in lap!

LOUSON DRUMS CLASSIC DELUXE CAJON
 P4404\$279.00★

- Cajonport™ bass port for booming bass sounds
- Removable snare
- External removable snare



CAJON TAB® 14" BASS
 P4402\$259.00★

If you are looking for a portable bass cajon drum, look no further.

- Lightweight and portable, can be worn on body using removable strap
- Removable snare



LP CAJON

P4500 LP Adjustable Snare Cajo\$289.99★

- Birch wood front plate w/MDF shell and black finish
- Adjustable snare with on/off and variable pressure settings
- Deep bass tones and optimal acoustic performance
- Rubber feet insulate vibrations from floor and prevent sliding
- Size: 19-3/4 x 11-3/4



Please see page 33 for Cajon Bags



LP CAJON THRONE
 P4486\$34.99★

Padded cajon seat for added player comfort



ANGEL CAJONS

ANGEL CAJONS

P4501 Koa Front Plate Cajon \$169.95..... \$152.96
 P4502 Mahogany Front Plate Cajon \$169.95..... \$152.96

Made from birch bodies with tone-wood front plates and equipped with an internal snare mechanism, Angel cajons give you a balanced sound with booming bass and percussive slaps.

Size: 12"x12"x15"



P4501

P4502

ANGEL MINI KIDS CAJONS

P4503 Blue Mini Kids Cajon \$79.95..... \$63.96
 P4504 Red-Orange Mini Kids Cajon \$79.95..... \$63.96

Size: 11.5"x10.5"x12.5"



P4503

P4504





CONGAS & BONGOS

P4255



DELUXE PROFESSIONAL BONGOS

P4255\$299.99★

Equipped with genuine calf skin heads, these drums are perfect for any style of music and are excellent for both studio recordings and live playing. Constructed of hand-selected, aged Siam Oak wood, and featuring brushed-chrome Classic Pro hoops and large tuning lugs.



P4363 P4364 P4366 P4366

DELUXE PROFESSIONAL CONGAS

- P4363 10" Requinto\$579.99★
- P4364 11" Quinto\$599.99★
- P4365 11-3/4" Conga\$649.99★
- P4366 12-1/2" Tumba\$699.99★

Constructed of hand-selected, aged Siam Oak wood, providing exceptional durability and unmatched sound, this drum is perfect for any style of music and great for both studio and recordings and live playing. Equipped with a genuine calfskin head, the 30" tall, extra-wide belly projects deep bass tones and great volume without sacrificing crisp, high sounds. Includes a single stand.

TOCA PLAYERS SERIES BONGO STAND

P4204\$109.95★

- Sturdy chrome and black steel construction
- Heavy duty, double locking
- Height and angle adjustable
- C-clamp bongo mount



TOCA DELUXE PRO BONGO STAND

P4205\$139.99★

- Heavy duty, double braced and double locking
- All chromed steel construction
- Height and angle adjustable
- C-clamp bongo mount



P4205

P4191

TOCA PLAYERS SERIES TUNABLE BONGO DRUMS

P4230N\$139.95★

- Asian oak wood shells
- 6 1/2" high
- 7" and 8 1/2" tunable bison skin heads
- EasyPlay rounded hoops and hardware
- Tuning wrench included
- Stand sold separately



P4230N

TOCA PLAYERS SERIES TUNABLE DOUBLE CONGA SET

Stand included
P4330N\$599.00★

- One 10" and one 11" drum
- Asian oak with natural finish
- Tunable bison skin heads
- Mounted on sturdy chromed, heavy duty, double locking, height adjustable tripod stand
- EasyPlay rims with four bolt tension plates
- Stand and tuning wrench included!

★ Starred items already discounted, not subject to further discounts — NET PRICES



P4330N

TOCA LOW RIDER BONGO STAND

P4191\$139.99★

- Angle fully adjustable
- Double braced, double locking legs for extra stability
- Ideal for seated playing



Educator or Educational institution status is required for discounted pricing featured in this catalog.

CONGAS & BONGOS



P4331

Rio Red color shown in photos of congas and bongos.

In keeping with Toca's green and environmentally-friendly policies, the wood for these drums is harvested from a plantation in Thailand, where the drums are then lathed and handcrafted by local musicians. This carefully managed resource is much easier on the environment than wood taken from primary forests.

SYNERGY DOUBLE CONGA SET P4331\$419.99★ Stand included

- 10" and 11" natural rawhide heads
- 28" two ply wood shell construction
- Black powder coated hardware
- Double braced, double locking, double conga stand included
- Tuning wrench included

SYNERGY TUNABLE BONGOS P4231\$89.99★

- 6" and 6.75" natural rawhide heads
- Two ply wood shell construction
- Black powder coated hardware
- Tuning wrench included



P4231

*same pricing for all colors

NEW COLORS NOW AVAILABLE!*

Color	Conga Set	Bongos
Natural	P4331NAT	P4231NAT
Amber	P4331AMB	P4231AMB
Bahama Blue	P4331BB	P4231BB
Rio Red	P4331	P4231
Tobacco	P4331TOB	P4231TOB

CONGA, DJEMBE & BONGO ACCESSORIES

DELUXE PADDED DJEMBE BAG

Backpack with padded straps and waist belt

- P4358 10" Small\$64.95★
- P4357 12" Medium\$69.99★
- P4356 13" Large\$84.95★



P4357



P4509

LP CAJON BAG P4509\$19.99★



P4511

LP DELUXE CAJON BAG P4511\$59.99★

- Durable, heavy duty, with padding
- Fits most cajons on the market



P4245

BONGO BAG P4245 ~~\$79.00~~..... \$63.20

Heavy duty bag with carrying handle and detachable shoulder strap (bongos not included)



P4315

RUBBER FEET FOR CONGAS P4315\$39.99★

Set of 4 rubber feet to elevate any standard conga for maximum tonal response.

TOCA "BASKET" DJEMBE STAND P4399\$44.95★

Designed for Toca Freestyle Djembes (see page 31)



P4310

SIT-DOWN CONGA STANDS\$39.95★ – All sizes

Fits most professional congas

- P4310 for 10" congas
- + P4311 for 11" congas
- + P4312 for 11¾" congas
- + P4313 for 12½" congas

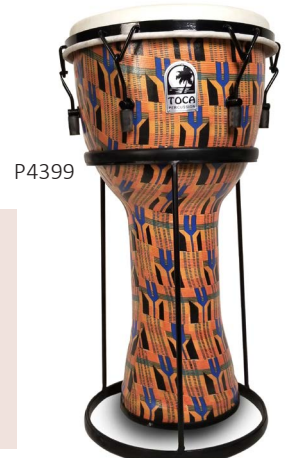

P4399

Register for educator account at Peripole.com



BODHRANS & ACCESSORIES



15" WALTON IRISH BODHRAN PACK

P4941\$104.95★

Include everything the beginning player needs to get started: Bodhran, handcrafted from the finest wood with a head made from real goatskin, along with a hardwood beater and carrying case. In addition, the Absolute Beginners: Bodhrán instructional DVD by Conor Long

BODHRAN DRUMS

†P4936	14" Bodhran	\$65.00.....	\$52.00
†P4937	16" Bodhran	\$70.00.....	\$56.00
P4938	18" Bodhran	\$75.00.....	\$60.00

- 3" deep wood shells
- Wood cross brace provides stability and easy grip
- Includes double head wood beater



P4938

BODHRAN CARE CREAM

P4939\$19.95★

- Prevents dryness and helps maintain sound for goatskin drum head



P4939

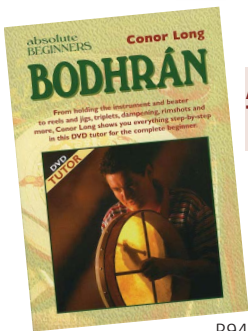

P4940

ABSOLUTE BEGINNERS BODHRAN TUTOR BY CONOR LONG

P4940 Absolute Beginners Bodhran Tutor Book and CD\$21.45★

P4941 Absolute Beginners Bodhran Tutor DVD\$26.45★

† Not Illustrated



Educator or Educational institution status is required for discounted pricing featured in this catalog.

TAMBOURINES



P4651

P4657

P4674

ECONOMY TAMBOURINES

NATURAL SKIN HEADS

P4651	6" Single Row	-\$10.50...	\$8.40
† P4653	8" Single Row	\$12.95...	\$10.36
P4657	10" Single Row	\$15.95...	\$12.76
P4659	10" Double Row	\$19.95...	\$15.96

HEADLESS

† P4652	8" Single Row	\$11.95...	\$9.56
P4656	10" Single Row	\$12.95...	\$10.36
† P4658	10" Double Row	\$16.95...	\$13.56



P4673

P4830

TOCA QUALITY TAMBOURINES

NATURAL SKIN HEADS

† P4670	7.5" Single Row	...\$26.99★
† P4672	9" Single Row	...\$29.99★
P4674	10" Double Row	...\$44.10★

HEADLESS

† P4671	7.5" Single Row	...\$24.99★
P4673	9" Double Row	...\$28.99★
P4675	10" Double Row	...\$29.99★
P4830	10" Deluxe plastic DJ	...\$34.99★

- High quality jingles
- High quality wood shells
- Natural wood finish or plastic as shown

Easy To Sanitize!

DELUXE ACACIA HARDWOOD HEADLESS TAMBOURINES WITH NICKEL AND BRASS JINGLES



P4852

† Not Illustrated

- Constructed from durable acacia hardwood
- Lightweight feel
- All versions use double-row, superior-quality, nickel and/or brass jingles as specified
- Nickel jingles create a lively sound. Brass jingles create a dry sound.
- Combination jingles give the best of both worlds!
- Rubber grip

† P4850	10" Acacia Tambourine with Nickel Jingles	...\$34.99★
† P4851	10" Acacia Tambourine with Brass Jingles	...\$44.99★
P4852	10" Acacia Tambourine with Nickel and Brass Jingles	...\$34.99★

★ Starred items already discounted, not subject to further discounts — NET PRICES

PERSONAL MUSIC KITS

For teachers going back to the classroom, these individual student kits are a great solution for kids to have their own personal instrumentarium without the need to share or touch others materials. For those who are learning and teaching from a distance, these kits will give your students engaging materials for living room music class!

All Personal Music Kits include a personal nylon string backpack for personal storage and ease of carrying.

P8811



P8817

P8810 Early Music Kit ~~\$11.65~~..... **\$10.50**

Includes: egg shaker, 27" movement scarf, pair of combination rhythm sticks (one fluted, one smooth), nylon string backpack.

P8811 Deluxe Early Music Kit ~~\$18.65~~..... **\$16.50**

Includes: two egg shakers, 27" movement scarf, pair of combination rhythm sticks (one fluted, one smooth), jingle bell stick, nylon string backpack.

P8812 Economy Middle Elementary Kit ~~\$18.45~~..... **\$13.95**

Includes: egg shaker, triangle with striker, chino tone block with wood mallet, nylon string backpack.

P8813 Middle Elementary Kit ~~\$25.09~~..... **\$19.95**

Includes: pair of mini maracas, 27" movement scarf, triangle with striker, chino tone block, nylon string backpack.

P8814 Deluxe Middle Elementary Kit ~~\$33.59~~..... **\$24.95**

Includes: pair of mini maracas, 27" movement scarf, triangle with striker, gourd tone block, wrist sleigh bells, nylon string backpack.

P8815 Economy Upper Elementary Kit ~~\$19.69~~..... **\$14.95**

Includes: pair of mini maracas, pair of light hardwood claves, one piece recorder, nylon string backpack.

P8816 Upper Elementary Kit ~~\$41.32~~..... **\$34.95**

Includes: pair of small toca maracas, pair of finger cymbals, pair of light hardwood claves, 27" movement scarf, one piece recorder, nylon string backpack.

P8817 Deluxe Upper Elementary Kit ~~\$53.95~~..... **\$39.95**

Includes: pair of small toca maracas, pair of finger cymbals, pair of light hardwood claves, Peripole® multi-bells, 27" movement scarf, Peripole® Halo® soprano recorder with full enrichment kit, nylon string backpack.

**Register for educator account
at Peripole.com**

Not seeing exactly the kit that fits your needs? Call our staff at 503-362-2560 during business hours to speak with one of our knowledgeable sales representatives to put together a custom kit order! We will work together with you to get the best price and kit for your classroom.

WORLD PERCUSSION PACKAGES

These sets have been selected for ease of ordering and as a guide for the teacher. We are offering these sets in three sections: **1) Basic Drum Packages, 2) Supplemental Packages, 3) First Circle Starter Set.** It is suggested that a deluxe or starter set be ordered from the Basic Drum Packages as well as a Supplemental Instrument Packages to create an exciting complete World Percussion classroom ensemble.





★ Starred items already discounted, not subject to further discounts — NET PRICES

BASIC DRUM PACKAGES		P8601 DELUXE \$6,329.12 \$5,259.28	P8602 STARTER \$3,569.44 \$2,883.54
Instrument guide and sample lesson by Kalani included with each package.			
P4150	9" Quinto Sienta® Conga	5	3
P4151	10" Sienta® Conga	5	3
P4152	11" Tumba Sienta® Conga	5	3
P4131	12" Key-Tuned Sienta® Djembe Tree-Bark™ Finish	1	1
P4452	12" Rope-Tuned Djembe Large	1	0
P4370	Talking Drum w/Mallet	1	1
P4918NN	Natural Notched Drum Set, 5 Hand Drums - Non-Tun.	1 set	1 set
P4230N	Professional Tunable Bongos on P4190 Sienta® Bongo Stand	1	0
P4231	Tunable Synergy Bongo on P4190 Sienta® Bongo Stand	0	1
P4305	Ngoma Leader Drum	1	0

SUPPLEMENTAL WOOD TONE, SHAKER, GUIRO & BELL TONE PACKAGES		P8603 DELUXE \$713.09 \$696.22	P8604 STARTER \$365.22 \$354.74
P5210	Rattler	1	0
P5206	Agogo Wood Block	1	1
P5405	Cabasa, Large	1	1
P5510	10" Shaker	1	1
P5508	8" Shaker	1	0
P5530	Chika Chakas	1 pr.	0
P5512	Caxixi Shaker, Large	2	1
P5400	Wood Guiro	2	2
P5112	LP Deluxe Wood Claves	3 pr.	2 pr.
P5505	Large Black Plastic Maracas	3 pr.	2 pr.
P5409	Toca Shekere	2	1
P3401	Agogo Bells w/Striker	1	0
P3207	6" Triangle w/Striker & Holder	2	2
P4830	10" Deluxe Headless Tambourine, DJ Plastic	1	0
P3306	6" Cowbell w/mallet	2	2

P8701 FIRST CIRCLE STARTER SET		\$470.59 \$413.33
P4918NN	Set of 5 Natural Notched Hand Drums	1 set
P5216	6" Frog Rasper	2
P5204	Hi-Lo Tone Block w/Mallet	2
P5400	Wood Guiro	1
P3005	Mini Cluster Bells	2
P3207	6" Triangle w/Striker & Holder	2
P3508	Wobble-Fit Finger Cymbals	2 pr
P5511	Small Caxixi	1
P5404	Standard Cabasa	1
P5535	Red Peripole® Egg Shaker	2
P5504	Standard Black Plastic Maracas	2 pr
P5505	Large Black Plastic Maracas	1 pr

Educator or Educational institution status is required for discounted pricing featured in this catalog.

 The musical instruments in our catalog are not toys. They are intended for use by adults and children with adult supervision. Unless otherwise stated, the instruments are not recommended for children under 3 years of age.

KALANI'S WORLD RHYTHMS

Instrument sets designed by Kalani Das to be used with his World Rhythms curriculum.

World Rhythms is a classroom curriculum of traditional world music arranged for drumming ensembles with songs from the Caribbean, Brazil, and West Africa. It's designed for easy accompaniment on ukuleles, guitar, piano, and Orff instruments.

The World Rhythms program was created by drummer, educator, and music therapist, Kalani Das, and is focused on helping students reach social and emotional goals while developing rhythm, timing, pitch, ensemble skills, and other important life skills, such as listening, collaboration and leadership.

Students learn how to tune, setup, and play the most commonly used drums and percussion instruments, preparing them for the next level of music making. World Rhythms instrument sets increase diversity in classroom music and may be mixed and matched for endless possibilities.

BASIC SET		P8720	\$1,812.18
Drums			
Model #	Description	Qty	
P4123	Large Dundun Bass Drum 15"	1	
P4501	Cajon	1	
P4152	Sienta® Tumba (Conga) 11" drum	1	
P4151	Sienta® Conga 10" Drum	1	
P4452	Toca Djembe 12" drum	1	
P4231	Toca Synergy Bongo Drum	1	
Hand Percussion			
P3305	5" Cowbell w/mallet	1	
P3401	Toca Agogo Bell	1	
P5504	Maracas – small, black, plastic	1	
P5610	Shaker – round, 10'X 2"	1	
P4327	Ghanaian Caxixi	1	
P5112	Deluxe Wood Claves	1	
P5204	Peripole® Hi-Lo tone block	1	

FULL SET		P8725	\$3,011.08
Drums			
Model #	Description	Qty	
P4122	Medium Dundun drum 12"	1	
P4123	Large Dundun drum 15"	1	
P4482	Surdo Drum 22" X 20"	2	
P2565	Surdo Mallet	2	
P4452	Toca Djembe 12" drum	2	
P4501	Cajon with gig bag	1	
P4152	Sienta® Tumba (Conga) 11" drum	1	
P4151	Sienta® Conga 10" Drum	1	
P4230N	Toca Players Series tunable bongo drums	1	
P4480	LP Tamborim	1	
P2560	LP Tamborim Striker	1	
Hand Percussion			
P3307	Cowbell - 7"	1	
P3305	Cowbell - 5"	1	
P3401	Toca Agogo Bell	1	
P5504	Maracas – small, black, plastic	1	
P5610	Shaker – round, 10'X 2"	1	
P4327	Ghanaian Caxixi	1	
P5112	LP Deluxe Wood Claves	1	
P5204	Peripole® Hi-Lo tone block	1	
P5222	Timber Drum Co Large Wood Block	1	

Suggested Harmony Instruments

- Ukuleles – see pages 54-61
- Guitars – see pages 64-66
- Orff Instruments – see pages 7-19

Suggested Embellishments

- Shekere – see page 40
- Cabasa – see page 40
- Rain Stick – see page 41
- Wind Chimes – see page 45
- Temple Blocks – see page 39
- Large 10" (Samba) Triangle – see page 44

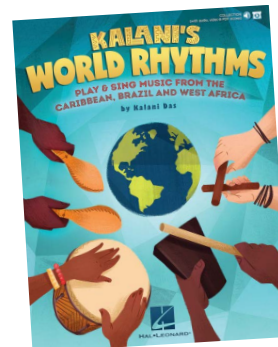

SEE BOOK ON PAGE 75

REFER TO PAGE 74-77 FOR WORLD PERCUSSION INSTRUCTIONAL BOOKS

MANDÉ INSTRUMENT ENSEMBLE SETS

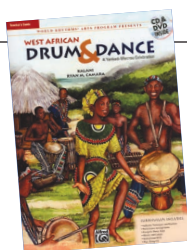

SEE BOOK ON PAGE 75.

Our special Mandé Instrument Ensemble Sets are designed to be used with the Book/CD/DVD set by Ryan M. Camara and Kalani Das, West African Drum and Dance: A Yankadi-Macrou Celebration. The Standard Sets contain the minimum number of instruments required to play all of the parts. The Deluxe Sets allow for greater participation.

For those of you who may already have Orff Xylophones, these sets are available without the Orff Xylophones as well.

MODEL #	DESCRIPTION	P8301 QTY	P8302 QTY	P8304 QTY	P8305 QTY
P4450	Small 8" Djembe	4		7	
P4452	Large 12" Djembe		4		7
P4121	Dundun Set w/Sticks	1 set	1 set	1 set	1 set
P4122	(Dundunba, Sangban, Kenkeni)				
P4123					
P4321	Dundun Bell Set w/Beaters	1 set	1 set	1 set	1 set
P4327	Seke-Seke (Caxixi)	2	2	4	4
P4323	Ksing Ksing	3 ea	3 ea	6 ea	6 ea
P4328	Whistle	1	1	1	1
P1101	Bergerault® Soprano Xylophone	1	1	3	3
P1111	Bergerault® Alto Xylophone	1	1	3	3
P1121	Bergerault® Bass Xylophone	1	1	1	2

REFER TO PAGES 8-9 FOR XYLOPHONES AND PAGE 28-29 FOR MANDÉ INSTRUMENTS

P8301	Mandé Standard Set with Small Djembes\$5,558.69	\$4,967.81
P8302	Mandé Standard Set with Professional Djembes\$5,918.69	\$5,327.82
P8304	Mandé Deluxe Set with Small Djembes\$9,420.43	\$8,305.20
P8305	Mandé Deluxe Set with Professional Djembes\$12,050.38	\$10,635.16

The following sets are identical to the corresponding model number above except that they **do not include any xylophones.**

P8301A	Standard - Small Djembe\$1,828.84	\$1,797.44
P8302A	Standard - Prof. Djembe\$2,188.84	\$2,157.44
P8304A	Deluxe - Small Djembes\$2,230.78	\$2,193.98
P8305A	Deluxe - Prof. Djembes\$2,860.78	\$2,823.98



WOOD-TONES AND GUIROS

Durable, select, seasoned, kiln-dried hardwoods. Sharp, clear resonant tones with a variety of pitches and timbres.

CLAVES

Particularly popular in Latin American music. To achieve a sharp, clear "click" tone, rest one clave across the cupped left hand between fingers and heel of palm. Strike sharply with other clave.

- P5101 LIGHT HARDWOOD CLAVES ~~\$7.95~~..... **\$6.36**
- P5102 GRANADILLO ROSEWOOD CLAVES ~~\$28.95~~..... **\$23.16**
- P5103 BERGERAULT® PRO SERIES CLAVES ~~.....\$49.95~~★
1" x 8 1/4" — Constructed of solid Honduran rosewood, renowned as the absolute best for professional marimba keys, these claves have unparalleled sound quality.
- P5112 LP DELUXE WOOD CLAVES**\$30.99**★
- P5113 LP KING CLAVES**\$36.99**★
Made from fiberglass to create a bright cracking sound. Loudest clave available! * **Easy To Sanitize!**



TONE BLOCKS — (mallet included with each)

- P5202 CHINO TONE BLOCK ~~\$7.95~~..... **\$6.36**
- P5203 GOURD TONE BLOCK ~~\$8.50~~..... **\$6.80**
Grooves on barrel for use as guiro.
- P5204 HI-LO TONE BLOCK ~~\$12.95~~..... **\$10.36**
A combination high-low, tone block-gourd block. **MADE IN USA**
- P5206 2 TONE AGOGO WOOD BLOCKS ON HANDLE**\$24.99**★



CASTANETS

- P5020 PLASTIC ELASTIC CASTANETS ~~\$4.95~~..... **\$3.96** * **Easy To Sanitize!**
- P5022 SINGLE WOOD CASTANET ~~\$3.25~~..... **\$2.60**
- P5021 LP ASPIRE PRO CASTANETS**\$24.99**★
- P5023 VALENCIA PROFESSIONAL CASTANETS**\$15.99**★
- P5107 LP CASTANET MACHINE**\$39.99**★
- P5105 LP ASPIRE SINGLE CASTANET ON HANDLE**\$16.99**★



GUIROS, SCRAPERS, RASPERS

- P5208 RATCHET**\$49.99**★
Chrome plated with large wooden ratchet wheel and steel crank.
- P5210 RATTLER**\$34.99**★
By holding the metal handle and "whacking" the wood ball a rattling percussive sound is produced.
- †P5190 LP VIBRASLAP STANDARD**\$51.99**★
The original and quality standard.
- P5191 LP VIBRASLAP DELUXE**\$69.99**★
Featuring larger deluxe sound chamber.
- P5211 GECKO CLACKER**\$19.99**★
Produces a rippling, clacking sound reminiscent of the movements of a wary gecko.
- P5400 WOOD GUIRO ~~\$14.95~~..... **\$11.96**
Fish shaped with grooves. Includes striker to provide typical scraping guiro sound.
- P5401 WOOD SHAKER/GUIRO**\$22.99**★
A great-sounding hardwood guiro combined with a cylindrical shaker.
- P5402 MINI WOOD SHAKER/GUIRO ~~\$10.95~~..... **\$8.76**



† Not Illustrated

WOOD BLOCKS & TEMPLE BLOCKS



BERGERAULT® MINI TEMPLE BLOCKS
P4550 \$169.95.... \$135.96

Set of five quality hardwood blocks mounted on a sturdy wood and metal stand. Mallets included.

P4550

MADE IN USA

CLOSED TEMPLE BLOCKS
P4562\$299.99★

Set of five quality hardwood blocks mounted on a bar with sturdy, height-adjustable, double-braced stand, and one pair of mallets.

P4562

LP SYNTHETIC GRANITE TEMPLE BLOCKS
P4582\$299.99★

Set of five tuned durable synthetic blocks mounted on steel bars. P4560S Stand sold separately.

P4582

OPEN PENTATONIC TEMPLE BLOCKS
P4570\$399.00★

Pentatonic wood temple blocks with an open back on each resonator box. Includes Includes stand and 1 pair of mallets.

P4570

TEMPLE BLOCK STAND
P4560S\$62.95★

- Heavy duty chrome steel
- Height adjustable
- Double locking

P4560S

LP BLAST BLOCKS

P4587	Low Green Block\$34.99★
P4588	Hi Yellow Block\$32.99★

* Easy To Sanitize!

P4587

SLAPSTICK
P5207\$46.99★

Premium hardwood with strong spring producing a crisp "crack" sound.

P5207

LP GROOVE BLOCKS

†P5260	LP GROOVE BLOCK SMALL\$37.99★
P5261	LP GROOVE BLOCK LARGE\$42.99★

P5261

LP RED OAK SLAP STICK
P5209\$39.99★

Delivers a classic "bullwhip" sound.

P5209

Made from North American maple these blocks feature full bodied tone with great dynamic range. Super durable, rubber feet make them able to be played on table top, in your hand or mounted on a stand.

P5261

HARDWOOD SQUARE TONE BLOCK
P5205\$28.00 ★

6" x 2 1/4" x 1 1/4" — Narrow, hollow, resonant chamber. Includes 1 Mallet

P5205

TIMBER DRUM COMPANY 6-TONE DRUM
P4507 18"W x 5.5"D x 6.25"H\$134.50★

Includes 1 pair of mallets.

Made in USA

P4507

LP HAND HELD JAM BLOCK
P5265\$39.99★

Produces the perfect woodblock/clave sound! Its unique shape provides maximum control and comfort. Made from LP's proprietary jenigor material, it is virtually indestructible and easy to clean and sanitize! Includes block and beater.

* Easy To Sanitize!

P5265

TIMBER DRUM COMPANY WOOD BLOCKS

†P5220	Small Wood Block	\$29.00.... \$23.20	MADE IN USA
P5221	Medium Wood Block	\$30.00.... \$24.00	
†P5222	Large Wood Block	\$34.00.... \$27.20	

Made of American hardwood with hand-rubbed oil finish, these professional quality wood blocks have a crisp bright tone and are tuned according to size. Includes 1 mallet.

P5221



SHAKERS AND SCRAPERS



TOCA SQUARE ALUMINUM SHAKERS

- P5614 4" Square Shaker\$24.99★
- P5618 8" Square Shaker\$29.99★

* Easy To Sanitize!



P5618

P5614



P5610 P5608 P5605

TOCA ROUND ALUMINUM SHAKERS

- P5605 5"X2" Round Shaker\$24.99★
- P5608 8"X2" Round Shaker\$28.99★
- P5610 10"X2" Round Shaker\$29.99★

* Easy To Sanitize!

P5510



P5508



P5506



TOCA PLASTIC SHAKERS

- P5506 6"x1 3/4" Round Shaker\$14.99★
- P5508 8"x1 3/4" Round Shaker\$16.99★
- P5510 10"x1 3/4" Round Shaker\$18.99★

* Easy To Sanitize!



Educator or Educational institution status is required for discounted pricing featured in this catalog.



P5403

LP PRO CABASAS/AFUCHES

- P5403 Mini Cabasa\$34.99★
Durable, hardwood construction, external cabasa beads.
- P5404 Standard Cabasa\$46.99★
Nickel-plated beads prevent rusting and locking up. Basic Brazilian type instrument.
- P5405 Large Cabasa/Afuche\$74.99★
Nickel-plated beads prevent rusting and locking up. Basic Brazilian type instrument. Large size.
- P5405L Deluxe Cabasa/Afuche\$79.99★
Nickel-plated beads prevent rusting and locking up. Basic Brazilian type instrument. Deluxe.

ECONOMY CABASAS

- P5417 Small 2.75" Cabasa \$24.95..... \$19.96
- P5418 Medium 3.35" Cabasa \$29.95..... \$23.96
- P5419 Large 4.5" Cabasa \$34.95..... \$27.96



P5405



P5405L



P5417



P5418



P5419

SHEKERES

- P5406 TOCA Pro Shekere\$149.99★
The Innovative design of this shekere is like a gourd in weight, thickness and shape, yet is made of fiberglass for durability. Professional quality sound.
- P5409 TOCA Shekere\$89.99★
Compact size and crisp sounding glass beads make this shekere an excellent value.



LP FIBER MARACAS

- P5481\$42.99★
Wood handles and round plastic shells perfect for "swirling" sound. Small steel shot creates a soft, crisp tone.



P5481

MARACAS

- P5504 TOCA Small Round Black Plastic Maracas Pair\$12.99★
- P5505 TOCA Large Round Black Plastic Maracas Pair\$16.99★



P5505



P5504



MINI MARACAS

- P5490 \$5.99..... \$4.79

Constructed from wipe-clean plastic and filled with steel shot, these small maracas are great for smaller hands and learning shaker techniques. Comes in a rainbow of colors. Colors cannot be specified on single orders.

LP PROFESSIONAL MARACAS

- P5480\$34.99★
Sold in matched pairs- one high pitch and one low pitch- for classic maraca sound. Produces a bold tone that cuts through sound. Great for performances!



P5480

* Easy To Sanitize!

★ Starred items already discounted, not subject to further discounts — NET PRICES

* Easy To Sanitize!

SHAKERS AND SCRAPERS



RAINBOW® EGG SHAKERS

- P5526 TOCA Single Egg Shaker \$2.50..... \$2.00
Color cannot be specified on single egg orders
- P5527 Set of 10 TOCA Mixed Colors \$24.99..... \$19.99
- P5535 Red Peripole® Egg Shaker\$2.25★
Best quality egg shaker with wonderful sound!

* Easy To Sanitize!



LP BIG EGG SHAKERS

- P5538 BLACK\$11.99★
- P5539 RED\$11.99★



* Easy To Sanitize!

CHIKA-CHAKAS

- P5530 \$31.95..... \$25.56

Exclusively From Peripole!

Explore a variety of shaker sounds, timbres and effects by holding and releasing the genuine drum-skin ends of these two hardwood shakers with two different grades of shaker beads inside. Sure to be popular with percussion enthusiasts.



Chika-Chaka

3 3/4" X 2 1/4", 1 3/4" Heads
P5530



P5520

LP DELUXE MONSOON RAIN STICK

- P5520\$129.99★

- 24" Tall
- Solid wood construction
- Incredible rainfall sound
- Sound lasts approximately 25 seconds

RAIN STICKS

THUNDER STICK!

- P5514 \$79.95..... \$63.96

The all-natural cactus "Thunder Stick" joins our family of rainsticks. This 50 inch plus "papa bear" of the rain stick family features the longest and loudest of the rain stick sounds!



P5514 "THUNDER STICK"



P5517



P5516

20" CACTUS

- P5516 \$24.95..... \$19.96

20" cactus. Creates the sounds of rain.

40" CACTUS

- P5517 \$33.95..... \$27.16

40" cactus. Creates the sounds of rain. Size listed above is approximate.



The musical instruments in our catalog are not toys. They are intended for use by adults and children with adult supervision. Unless otherwise stated, the instruments are not recommended for children under 3 years of age.

ANIMAL RASPERS

FAMILY OF FROGS

- † P5212 2" Frog Rasper \$11.95... \$9.56
- † P5214 4" Frog Rasper \$15.95... \$12.76
- † P5216 6" Frog Rasper \$21.95... \$17.56
- P5218 8" Frog Rasper \$29.95... \$23.96
- † P5219 12" Frog Rasper \$62.95... \$50.36



P5218



P5212



P5234



P5231



P5237

ANIMAL FRIENDS

- P5231 Cricket Rasper \$14.95... \$11.96
- P5237 Small Pig Rasper \$11.95... \$9.56
- † P5238 Large Pig Rasper \$14.95... \$11.96
- P5233 Iguana Rasper \$14.95... \$11.96
- P5234 Cat Rasper \$16.95... \$13.56
- † P5245 Gecko Kazoo \$11.95... \$9.56



P5233



HOOTINI THE OWL WHISTLES

- † P5230 Small \$9.95... \$7.96
- P5239 Medium \$12.95... \$10.36
- † P5240 Large \$16.00... \$12.80

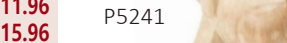

ELEPHANT WHISTLES

- P5241 Small Elephant Whistle \$14.95... \$11.96
- † P5243 Large Elephant Whistle \$19.95... \$15.96



P5241

LP CONGA SHAKERS SET OF 3

- P5537\$19.99★

Set of 3 ergonomic conga-shaped shakers giving you a full spectrum of sounds in 3 volumes: soft (white), medium (blue), and loud (red).

* Easy To Sanitize!



P5537

TOCA WOODEN RATTLES

An amazing new sound for your percussion group in three amazing styles of hardwood pod rattles.

- P5541 Wood Pod Rattles Hanging Group\$94.95★
- P5542 Wood Pod Rattles with Handle\$64.95★
- P5543 Wood Pod Rattles Ankle/Wrist\$34.95★



P5542



P5540



P5543

P5541

SEED POD RATTLE

- P5540\$19.99★

★ Starred items already discounted, not subject to further discounts —NET PRICES

EARLY PERCUSSION

P4103R RHYTHM CLUB®\$38.95★

- Features Acousticon® shell
- Pre-tuned Suede® drumhead
- Comes with red tip drum stick
- Compact size ideal for classroom
- 10" x 5"



P4103R



P4104R KIDS PERCUSSION®\$59.95★

- Features Acousticon® shell
- Pre-tuned Skyndee® drumhead
- Vibrant Rainforest finish
- 10" x 7.5"



Remo Floor Drums produce a fun, professional, high quality sound. Ideal for classrooms and drum circles, can be played with hands, mallets or sticks.

P4104R



PERIPOLE® TYMPTONE TOM-TOM

P4001 \$34.95..... \$27.96

Two thick natural rubber heads. Red gloss-finished thick fiber shell. 6" x 7". Braided cord laced through holes reinforced with brass rings. Double-headed wood safety mallet included.

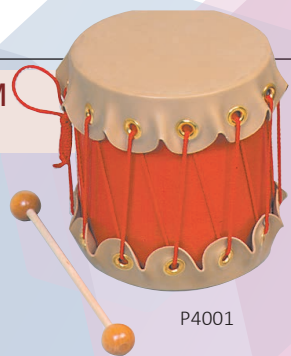

P4001

MADE IN USA

PAPOOSE TOM-TOM

P4003\$18.95★

Two skin heads. Red gloss-finished thick fiber shell. 5" x 5". Double-headed wood safety mallet included.



P4003

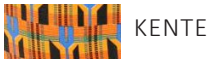

KENTE



PURPLE GLOW



BLUE



GREEN



VIOLET



P4156



RHYTHM STICKS

†P5011 SMOOTH NATURAL RHYTHM STICKS\$3.50★

1 pair 14" long sticks w/natural finish

†P5012 FLUTED NATURAL RHYTHM STICKS\$3.50★

1 pair 14" long sticks w/natural finish

P5013 COMBINATION NATURAL RHYTHM STICKS\$3.50★

1 pair 14" long sticks w/natural finish

One smooth, one fluted.

MADE IN USA



P5013

† Not Illustrated

SHORT HICKORY RHYTHM STICKS

P5015\$6.50★

Crafted from resilient American Hickory, rhythm sticks are ideal for elementary music educators
8" in length and .75" in diameter

MADE IN USA



P5015

TOCA FREESTYLE TOM TOM FLOOR DRUMS

9.25"W x 8.25"H Includes 1 pair of mallets.

- P4154 Toca Purple Glow Floor Drum\$58.95★**
- P4155 Toca Kente Small Floor Drum\$58.95★**
- P4156 Toca Red Small Floor Drum\$58.95★**
- P4157 Toca Blue Small Floor Drum\$58.95★**
- P4158 Toca Green Small Floor Drum\$58.95★**
- P4159 Toca Violet Small Floor Drum\$58.95★**



P5301



PERIPOLE® SAND BLOCKS

† P5301 SAND BLOCKS\$11.50★

3" x 5". Natural finish oak or similar wood. Sure-grip knob handles.

MADE IN USA

P5303 PAT-A-CAKES\$7.50★

Same as P5301 except no sandpaper. Wood taps.

MADE IN USA

★ Starred items already discounted, not subject to further discounts — NET PRICES



Educator or Educational institution status is required for discounted pricing featured in this catalog.

UNIQUE PERCUSSIVE TONES



UNIQUE PERCUSSIVE TONES



P3965

LP 8" METTA DRUM

P3965\$199.99★

LP Metta Drums are designed to be used in musical as well as therapeutic settings and produce peaceful, soothing drone sounds from its eight tongues tuned to a Tanpura scale. Included magnets can be used to alter the tuning for other sonic options.

Includes two rubber mallets and a nylon carrying bag.

P3970



SELA STAINLESS STEEL HANDPAN

P3970\$1,999.00★

The handpan is the perfect combination of percussion and melody instrument. It consists of two thin, assembled stainless steel bowls. The halves are elaborately hammered by hand as part of the manufacturing process. This creates dents and a small hill in the middle of the body. These surfaces form the various sound fields. Surrounded by a circle of 8 tones, the central note lies in the middle of the handpan. If the fields are played, bright, long-lasting sounds are produced. A high-quality and padded bag is included

- Tuning: D Amara (440 Hz)
- Tones: D3/ A3, C4, D4, E4, F4, G4, A4, C5
- Diameter: 22.4"

SELA TONGUE DRUMS

- P3980\$45.99★
5.5" TONGUE DRUM (C PENTATONIC)
 P3985\$55.99★
6" TONGUE DRUM (C MAJOR)

With its warm and soothing sound, Sela small Tongue Drums are suitable for relaxation in everyday life as well as for the early musical education of children. Since all six tone fields of the Sela Melody Tongue Drum 5.5" are on the pentatonic C scale and 6" are on the C Major Scale, a harmonic melody is always created when playing without any "wrong" notes.



P3980



P3985

ANGEL LARGE TONGUE DRUMS

- P3950 LARGE \$116.99... \$99.44
11 Note Tongue Drum (C Major)
 P3955 X-LARGE \$199.99... \$169.99
15 Note Tongue Drum (C Major)

Angel long-resonating large tongue drums are a great upgrade in sound and power. With more notes (11 or 15), they are on the C Major Scale, a harmonic melody is always created when playing without any "wrong" notes. Includes carrying bag and mallets.



P3955

P3950

NEW!

FLEX-A-TONES

P3908 SMALL\$42.99★

- Creates eerie, wavy, saw blade-like sounds through varied pitches
- Bend the steel spring with thumb while mallet strikes surface
- With a little practice pitches can be controlled so songs can be played



P3908



★ Starred items already discounted, not subject to further discounts — NET PRICES



P5551



P5550

THUNDER DRUM

Create the sound of a thunder storm!

- P5551 Small Purple Lightning Thunder Tube\$14.95★
 P5550 Large Purple Lightning Thunder Tube\$36.95★

MUSICAL WASHBOARD

Includes 3 small thimbles for easy play
 P5560\$29.95★

P5560



LP FOOT TAMBOURINE

P4600\$14.99★

P4600



WASHBOARD TIE

Make a musical fashion statement! Includes thimble for easy play

P5561\$24.95★

P5561



PLASTIC KAZOOS

P6750\$1.50★

P6750



* Easy To Sanitize!

METAL SPOONS

P5601\$14.95★

P5601



* Easy To Sanitize!



The musical instruments in our catalog are not toys. They are intended for use by adults and children with adult supervision. Unless otherwise stated, the instruments are not recommended for children under 3 years of age.



BELL-TONE INSTRUMENTS

- Made from tempered metal alloys to produce the finest bell tones
- Highly polished and plated
- Clear resonant sound



Peripole® Sleigh Bell Products are **MADE IN THE USA** for the Highest Quality and Sound!

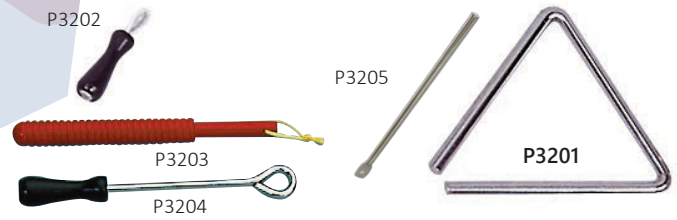

TRIANGLES		
P3201	6" TRIANGLE WITH STRIKER\$5.50★
P3201A	6" TRIANGLE NO STRIKER\$4.95★
P3202	PERIPOLE® BLACK ENAMELED KNOB HOLDER MADE IN USA	\$2.25... \$1.80
P3203	PERIPOLE® "LONGRIP NO-TWIST" HOLDER Fluted handle. MADE IN USA	\$4.50... \$3.60
P3204	PERIPOLE® SAFETY STRIKER	\$6.25... \$5.00
P3205	TRIANGLE STRIKER	\$1.50... \$1.20
P3206	COMPLETE SET – TRIANGLE, LONGRIP HOLDER, SAFETY STRIKER	\$14.95... \$11.96
P3207	6" TRIANGLE, STRIKER & HOLDER	\$7.25... \$5.80

TREETWORKS TRIANGLES		
†P3214	4" Pro Triangle\$27.95★
†P3215	5" Pro Triangle\$34.95★
P3216	6" Pro Triangle\$39.95★
†P3218	8" Pro Triangle\$52.95★
†P3220	10" Pro Triangle\$67.95★

Professional quality. Made of large diameter, extremely hard carbon steel for a brilliant, shimmering tone.

SABIAN PROFESSIONAL TRIANGLES		
P3225	PRO SABIAN 6" TRIANGLE\$61.25★
Individually crafted from pure B8 cymbal alloy (8% tin, 92% copper with traces of silver) to produce bright, shimmering sounds with ample sustain.		
P3232	PRO SABIAN 6" HAND HAMMERED TRIANGLE\$109.99★
Individually crafted and hand hammered from pure B8 cymbal alloy (8% tin, 92% copper with traces of silver) to produce bright, shimmering sounds with ample sustain.		



PERIPOLE® JINGLE CLOG		
P3100		\$7.00..... \$5.60
Nickel-plated tambourine jingles mounted on solid round base with fluted handle.		

HANDLE BELLS		
P3001	PERIPOLE® WRIST SLEIGH BELLS	\$7.95... \$6.36
Four 1" nickel-plated bells riveted to red heavy nylon webbing. Bells guaranteed not to come off. MADE IN USA		
P3001D	PERIPOLE® DELUXE WRIST SLEIGH BELLS	\$8.95... \$7.16
Four 1 1/4" nickel-plated bells riveted to heavy nylon webbing. Bells guaranteed not to come off. MADE IN USA		
P3002	PERIPOLE® JINGLE BELL STICK	\$4.50... \$3.60
1 1/2" bell. MADE IN USA		
P3003	PERIPOLE® MULTI-BELLS	\$7.95... \$6.36
Three 1" sleigh bells riveted to heavy plastic handle. MADE IN USA		
P3003D	PERIPOLE® DELUXE MULTI-BELLS	\$8.95... \$7.16
Three 1 1/4" sleigh bells riveted to heavy plastic handle. MADE IN USA		
P3004	PERIPOLE® CLUSTER BELLS	\$34.95... \$27.96
25 sleigh bells on a sturdy wood handle. MADE IN USA		
P3005	PERIPOLE® MINI CLUSTER BELLS	\$18.00... \$14.40
9 sleigh bells mounted on wood handle. MADE IN USA		
P3006	PERIPOLE® DELUXE CLUSTER BELLS	...\$49.99 ★
Professional, premium quality large sleigh bells mounted on heavy hardwood handle with comfortable grip.		

The musical instruments in our catalog are not toys. They are intended for use by adults and children with adult supervision. Unless otherwise stated, the instruments are not recommended for children under 3 years of age.

† Not Illustrated

BELL-TONE INSTRUMENTS



TWIN TOCA CHROME AGOGO BELLS

P3401\$64.99★ * Easy To Sanitize!

Chrome finish. Pitched in 5ths. Beater included.



P3401



P3306

COWBELLS WITH Mallet

†P3305	5" Cowbell	\$17.95...	\$14.36
P3306	6" Cowbell	\$18.95...	\$15.16
†P3307	7" Cowbell	\$19.95...	\$15.96

* Easy To Sanitize!



P2543

COWBELL BEATER

P2543 Professional Cowbell Beater\$18.99★



MINI STEEL AGOGO BELLS

P3402 \$13.95..... \$11.16

* Easy To Sanitize!



P3402

TOCA PLAYERS SERIES COWBELL

- Improved full-side seam weld
- Black powder coat finish
- Eyebolt assembly

P3350	5.75" Cowbell\$29.99★
P3351	6.88" Cowbell\$34.99★
P3352	9.5" Cowbell\$39.99★

* Easy To Sanitize!



P3351



P3210

LP ONE-HANDED TRIANGLE

P3210\$59.99★

- New and innovative
- Enables playing complex Latin and Brazilian rhythms and more with one hand
- Designed by Broadway percussionist, Doug Hinrichs (The Heights)
- Easy grip and access to striker enables selective muffling of sound

 Educator or Educational institution status is required for discounted pricing featured in this catalog.

SOLID BAR CHIMES

P3900\$159.95★



P3900

TOCA METAL GUIRO/SHAKER

P5420 \$64.99★

Cylindrical 2" x 8" metal shaker with three prong metal scraper.



P5420



20 chimes, made of a special aluminum alloy, attached to sturdy wood and metal tabletop stand. Can be played by strumming in glissando fashion with the fingers across the chimes or with a triangle striker (not included). Creates an exotic effect.



The musical instruments in our catalog are not toys. They are intended for use by adults and children with adult supervision. Unless otherwise stated, the instruments are not recommended for children under 3 years of age.



BELL TREES

P3301 LP HAND HELD BELL TREE W/BRASS Mallet\$2,29.99★

- 14 brass bells with a solid wood handle

P3302 LP BELL TREE W/STAND & BRASS Mallets\$499.99★

- 26 brass bells ranging from high to low pitch
- Mallets store in steel stand



P3302



P3301

★ Starred items already discounted, not subject to further discounts — NET PRICES



CYMBALS

★ Starred items already discounted, not subject to further discounts — NET PRICES

BRASS FINGER CYMBALS

P3505 DANCER'S CYMBALS-THIN \$22.95..... **\$18.36**

Set of two pairs in pouch. Attached elastic slings.

P3507 FINGER CYMBALS-THICK**\$21.50★**

One pair. Richer sound.

P3508 PERIPOLE® "WOBBLE-FIT" CYMBALS**\$24.95★**

Deluxe heavy brass finger cymbals with attached "Wobble-Fit" wooden knobs to extract best sound.



PERIPOLE® BRASS PAGODA BELLS

2 bells on a braided cord provide a rich, penetrating sound when tapped together

P3510 FLAT PAGODA BELLS \$24.95..... **\$19.96**

P3511 BELL-SHAPED PAGODA BELLS \$32.95..... **\$26.36**

P3512 DELUXE ROUND HEAVY BRASS PAGODA BELLS \$38.95..... **\$31.16**



8" SPUN BRASS CYMBALS

P3651 8" DIAMETER WITH COMBINATION STRAPS, KNOB HOLDERS, AND MALLETS**\$34.95★**

Can be used as gong or crash cymbals, pair.

P3653 8" DIAMETER WITH KNOBS ONLY**\$29.95★**

Crash cymbals, Pair.



TREWORKS FINGER CYMBALS

P3504**\$33.95★**

- Professional quality sand casted bronze
- 2.5" diameter

† Not Illustrated

P3504



PROFESSIONAL SPUN BRASS CYMBALS

To be mounted on stand or held in the hand with special holder. Cymbal stand, holders, brushes, sticks and mallets to be ordered separately.

Features a "bright" crash/splash-like sound with multiple overtones.

SABIAN CYMBALS

†P3710S 10" DIAMETER**\$41.99★**

†P3712S 12" DIAMETER**\$84.99★**

P3714S 14" DIAMETER**\$57.50★**

†P3716S 16" DIAMETER**\$87.99★**

†P3718S 18" DIAMETER**\$102.99★**

†P3720S 20" DIAMETER**\$119.99★**

CYMBAL STAND

P3800**\$49.95★**

Adjustable. Three-rise, swivel top.

BOOM CYMBAL STAND

P3801 \$69.95..... **\$55.96**

SABIAN NYLON CYMBAL STRAPS PAIR

†P3810**\$8.99★**

CYMBAL BRUSHES

†P2540**\$19.95★**

Pair (refer to pg. 21)

CYMBAL DRUM STICKS

†P2545 \$9.95..... **\$7.96**

Nylon tip, pair (refer to pg. 21)

†P2546 \$9.95..... **\$7.96**

Wood tip, pair (refer to pg. 21)



Please note: Lead can be a minor additive in manufactured brass. Although most products on this page have a protective lacquer coat, we cannot guarantee that any brass is completely free of lead.

GONGS & ACCESSORIES

SABIAN SYMPHONIC GONGS

†P3924S 24" Symphonic Gong**\$479.99★**

P3926S 26" Symphonic Gong**\$569.99★**

†P3928S 28" Symphonic Gong**\$649.99★**

SABIAN CHINESE GONGS

†P3930CG 30" Chinese Gong**\$974.99★**

†P3934CG 34" Chinese Gong**\$1,640.00★**

P3940CG 40" Chinese Gong**\$2,790.00★**

SABIAN GONG STANDS

P3926EGS Adjustable stand for up to 26" Gong**\$142.99★**

P3940EGS Adjustable stand for up to 40" Gong**\$163.99★**

†P3940EWGS Wheeled stand for up to 40" Gong**\$239.99★**

SABIAN GONG MALLETS

†P2552 Small Gong mallet (see page 21)**\$68.49★**

†P2553 Large Gong mallet (see page 21)**\$73.99★**

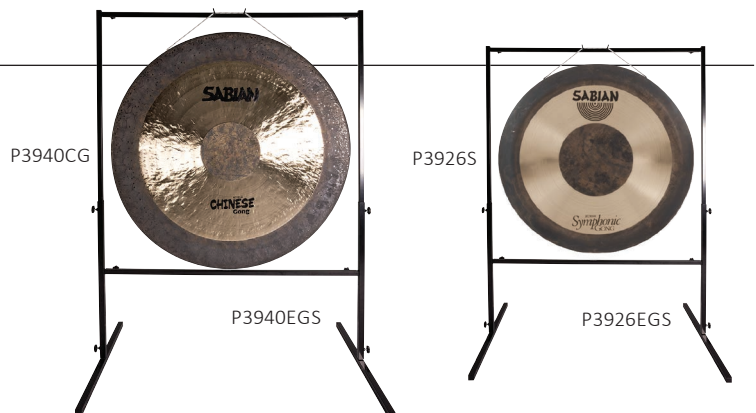

Educator or Educational institution status is required for discounted pricing featured in this catalog.

BELL KITS

8 NOTE RAINBOW® HAND BELLS

P3222 \$34.95..... \$27.96

NEW!

P3222



8 NOTE RAINBOW® TOUCH BELLS

P3221 \$69.95..... \$55.96

NEW!

P3221



8 NOTE RAINBOW® JUNIOR DIATONIC SONG BELLS

P2214 \$13.95..... \$11.16

Perfect for the early music classroom. Includes 1 pair of mallets.

P2214

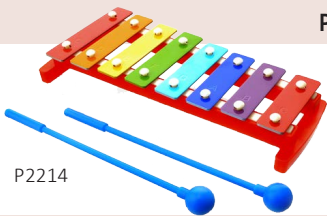

NEW!

8 NOTE RAINBOW® JUNIOR PLASTIC RESONATOR BELL SET

P2204 \$19.95..... \$15.96

Perfect for younger children, these rainbow song bells come in a set of 8 with a pair of mallets and plastic carrying case.

P2204



P2201

EIGHT STEP STAIRCASE

P2201 \$34.50..... \$27.60

Frame on which to arrange resonator bells to help develop scale and pitch concepts. Bells not included.

27 NOTE STARTER SONG BELLS

P2215 27 NOTE STARTER SONG BELLS \$32.95..... \$26.36

Black and white bars

P2216 27 NOTE STARTER SONG BELLS \$32.95..... \$26.36

Rainbow® bars



P2216

- .8" wide nickel bars
- Built into easy to carry and store case
- Includes 1 pair of mallets
- Available in black and white or rainbow keys
- Range from G5-A7

P2215



OCTAVE RESONATOR CHIME BARS

P2205\$89.99★

P2205



SPECIFICATIONS

- Chime bars feature a bright sustained resonating sound
- Highly resonant steel chimes mounted on a chamber crafted from environmentally friendly rubber wood
- Pair of wooden playing mallets included

D AND A BAR ALTO RESONATOR BELL SET WITH MALLETS

P2102 \$19.95..... \$15.96

P2102



- Bars mounted on individually tuned solid resonator chambers (D5 & A5)
- Two long-handle, soft rubber mallets included
- Great for learning beginning musical concepts
- Rounded bar corners - not sharp!



P2325C

CHROMATIC SONG BELLS

P2325C 25 NOTE\$124.95★
Chromatic (2 octaves) (A5-A7)

SPECIFICATIONS

- 1 1/8" wide x 1/16" thick aluminum bars mounted on wood frame
- Note names on bars
- Black and white bars arranged like piano keyboard
- Includes one pair mallets

25 NOTE CHROMATIC RESONATOR BELL SET

P2225\$379.95★

- Accurate A440 tuning with perfect tone stability and retention.
- aluminum alloy bars with notes stamped into metal.
- Impact resistant plastic chambers
- Includes a mallet for each bar and carrying case.



P2225

NEW!



The musical instruments in our catalog are not toys. They are intended for use by adults and children with adult supervision. Unless otherwise stated, the instruments are not recommended for children under 3 years of age.



RHYTHM SETS



P8025

ECONOMY SET	\$139.29 \$130.71	\$232.14 \$216.18	\$318.58 \$298.43
Number of Students	15	25	35
Model Number & Description	P8015	P8025	P8035
P5013 Combination Rhythm Sticks, pair	3	5	7
P3653A 8" Cymbals with knobs + mallets, each	1	2	2
P3201 6" Triangles with striker, ea.	2	2	4
P3202 Triangle holder, each	2	2	4
P5301 Standard Sand Blocks, pair	1	2	4
P5303 Pat-a-Cakes, pair	1	2	3
P3001 Wrist Bells, each	2	4	5
P3100 Jingle Clogs, each	2	5	5
P5203 Gourd Tone Blocks with mallet, each	1	1	2
P5505 Large Plastic Maracas, pair	1	1	2
P9611 Sound Stories, by Cak Marshall	1	1	1

★ Starred items already discounted, not subject to further discounts — NET PRICES



The musical instruments in our catalog are not toys. They are intended for use by adults and children with adult supervision. Unless otherwise stated, the instruments are not recommended for children under 3 years of age.

STARTER SET

STARTER SET		
P7050SS \$191.39..... \$175.63		
1	P4103R	Rhythm Club Tom Drum
1	P4003	Papoose Drum and mallet
1	P4651	6" Tambourine
1	P5301	Sand Blocks, pair
1	P5203	Gourd Tone Block and mallet
2	P5012	Fluted Rhythm Sticks, pair
2	P3201A	6" Triangle, without striker
2	P3203	Longrip Triangle Holder
2	P3204	Safety Triangle Striker
1	P3005	Mini Cluster Bells
1	P3003	Multi-Bells
1	P3002	Jingle Bell Stick
1	P3001	Wrist Bells
1	P5504	Small Black Maracas, pair
3	P5535	Red Peripole® Egg Shaker
1	P9611	Sound Stories by Cak Marshall



P7050 SS

RHYTHM SETS



ENRICHED SET	\$257.59 \$235.24	\$330.49 \$297.16	\$378.69 \$340.07
Number of Students	15	25	35
Model Number & Description	P8515	P8525	P8535
P4156 TOCA Freestyle® Tom Tom	1	1	1
P4001, Tymptone Tom-Tom Drum + mallet, each	1	1	1
P4003 Papoose Drum + mallet, each	1	1	1
P4653 8" Tambourine, each	1	2	2
P3651 8" Cymbals with straps, knobs and mallets, pair	1	1	1
P3507 Thick Finger Cymbals pair	1	1	1
P3201 6" Triangle, each	1	3	3
P3203 Longrip Triangle Holder, each	1	3	3
P3005 Mini Cluster Bells, each	0	1	1
P3003 Multi-Bells, each	1	1	2
P3002 Jingle Bell Stick, each	1	1	2
P3001 Wrist Bells, each	1	2	2
P3100 Jingle Clogs, each	1	2	4
P5013 Combination Rhythm Sticks, pair	1	3	4
P5301 Jumbo Sand Blocks, pair	1	1	2
P5203 Gourd Tone Block and mallet, each	0	1	1
P5204 Hi-Lo Tone Block and mallet, each	1	1	1
P5505 Large Black Plastic Maracas, pair	1	1	1
P5535 Red Peripole® Egg Shaker, each	0	0	3
P9610 Beatworx, by Cak Marshall	1	1	1



PLEASE NOTE: Lead can be a minor additive in manufactured brass. Although these cymbals have a protective lacquer coat, we cannot guarantee that any brass is completely free of lead.

TEACHERS NOTE:

A variety of rhythm instrument sets have been prepared. The aim of our Education Department in arranging these outfits was primarily to effect variety and balance in tone color and instrumentation. Economy Sets and Enriched Sets were created to serve different budget considerations. All sets contain the same high-quality, fully guaranteed instruments. The price differential is due to the inclusion of more expensive items such as drums and tambourines.

EASY HOLD ADAPTIVE ASSISTANCE

P9810	4" Yellow SM Hole Pair\$14.99★
P9811	4" Pink LG Hole Pair\$14.99★
P9812	4.5" SM Green Pair\$14.99★
P9813	5" Orange Pair\$14.99★
P9814	5-1/4" Purple SM Hole Pair\$15.99★
P9815	5-1/4" Blue LG Hole Pair\$15.99★
P9816	6.5" Teal Pair\$15.99★
P9817	7-1/4" Grey Pair\$16.99★
P9818	7.5" LG Green Pair\$19.99★
P9819	Classroom Set of 7\$49.99★

(One of Each: Yellow, Pink, Green, Orange, Blue, Purple, Teal)

EasyHold design gives children and adults the ability to hold onto tons of items with ease. EasyHold grip assist comes in multiple sizes to help get a better grip on small to large objects. These flexible universal cuffs attach securely to enable a comfortable grip. EasyHold straps are made of soft, flexible, food-grade silicone, hypoallergenic, and latex free. Wash in the dishwasher or clean with disinfectant wipes.



* Easy To Sanitize!

Educator or Educational institution status is required for discounted pricing featured in this catalog.

BOOMWHACKERS®

* Easy To Sanitize!

Tuned plastic percussion tubes recommended for ages: 3 yrs +

- P6800 Whack Pack (BPXS)\$59.95★**
 - Includes 8-note diatonic set, xylotote, one pair of P6807 Mallets, one octavator cap and Whack-a-Doodle-Do songbook
- P6801 C Major Diatonic Set (BWDG)\$24.95★**
 - 8-note set, starting at middle C
- P6802 Chromatic Set (BWCG)\$19.95★**
 - In same range as P6801 diatonic set. Includes C#, D#, F#, G#, Bb
- P6803 C Major Pentatonic Scale Set (BWPQ)\$22.00★**
 - 6 tubes from middle C to C above
- P6804 Treble Extension Set (BWEQ)\$17.50★**
 - Starts where P6801 Diatonic Set ends. Includes C#, D, D#, E, F, F#, G
- P6805 Bass Diatonic Set (BWJG)\$49.95★**
 - 7-note set starting at C below middle C
- P6806 Bass Chromatic Set (BWKQ)\$37.95★**
 - In same range as P6805 Bass Diatonic Set. Includes C#, D#, F#, G#, Bb
- P6807 Whacker Mallets (ML1G)\$11.99★**
 - 11" x 1". Pair
- P6808 Octavator Tube Caps (OC8G)\$15.95★**
 - Place on end of Boomwhacker® to lower pitch one octave
 - Set of eight
- P6809 XyloTote Tube Holder (XT8G)\$29.99★**
 - Insert tubes to play with mallets
 - Roll up to make carrying tote (as shown with P6800 Whack Pack)
 - Tubes sold separately
- P6810 Move and Play Boomwhacker® Kit (BWMP)\$119.99★**
 - Ideal for music classes, P.E. classes or any activity incorporating music and dance.
 - Includes the following 25 Boomwhackers®: C, D, G, A (3 of each). E, F, F#, Bb, B (2 of each). C#, D#, G# (1 of each).
 - Comes with enough Boomwhackers® so a group of 12 or more can perform all the included songs and choreography found in the activity book and CD/DVD.
- P6811 Boomwhacker® Traveling Tote (BWMP-BAG)\$27.99★**
 - Holds up to 25 Boomwhackers®
 - Has pockets for Octavator Caps, and books.
 - Boomwhackers® and Accessories sold separately
- P6812 Boomwhackers® Backpack\$28.95★**
 - Dimensions: 26.5"H x 15"W x 10"D
 - Two Zippered Compartments:

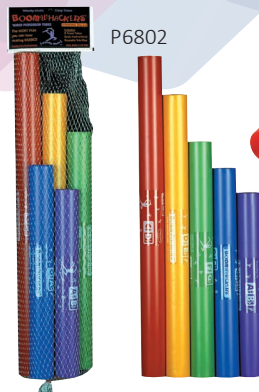

Educator or Educational institution status is required for discounted pricing featured in this catalog.

★ Starred items already discounted, not subject to further discounts — NET PRICES



The musical instruments in our catalog are not toys. They are intended for use by adults and children with adult supervision. Unless otherwise stated, the instruments are not recommended for children under 3 years of age.

Note Knacks by Kristin Pugliese are a system of music notation blocks that even your youngest learners can hold and manipulate to create and perform their own musical compositions. These specially proportioned blocks display a musical note on one side and its corresponding rest on the back. Blocks represent whole, half, quarter, eighth, and sixteenth notes and are color coded so the name of each color says the rhythm. Note Knacks fit into three time signature frames that ensure children stay within the parameter of conventional notation while enjoying the freedom to create. Above all, Note Knacks are simple to understand and easy to use!

- Enables hands on learning.
- Reveals the method behind notation.
- Explains notes and rests simultaneously.
- Teaches music standards while encouraging creativity.
- Creates tangible assessments.
- Provides concert material with minimal preparation.
- Suitable for large groups, small groups, and one on one instruction.
- Appropriate for all types of learners from kindergarten up.



P8905

NOTE KNACKS DICE

P8905\$36.71★

Includes 3 fabric dice- each with its own set of notation on it. One shows time signatures, the second shows notes, and the last shows rests. These dice make learning notation a game!

NOTE KNACKS SET OF LESSON PLANS

P8909 Data Disk\$24.95★

Kristin's original 25 lesson plans that walks you through the program step-by-step!



P8909

NOTE KNACKS PUSHING THE LIMITS! ADVANCED LESSON PLANS

†**P8910** Data Disk\$18.95★

12 lesson plans that take composition to a whole new level!



P8901

NOTE KNACKS STUDENT SET

P8901\$43.20★

Includes 1 whole note, 2 half notes, 4 quarter notes, 8 eighth notes, 16 sixteenth notes, a 2/4 time signature frame, a 3/4 time signature frame, and a 4/4 time signature frame.

NOTE KNACKS CLASSROOM BASIC SET

P8907\$155.94★

Includes 3 sets of 31 blocks and a set of lesson plans.



P8907

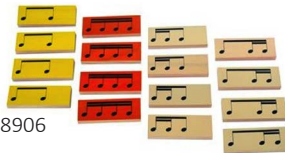

P8906

NOTE KNACKS BEAM SET

P8906\$37.71★

This set has all of the common beamed notes! There are four blocks each of:

- 2 beamed eighths
- 4 beamed sixteenths
- 2 sixteenths to 1 eighth
- 1 eighth to 2 sixteenths

P8903



NOTE KNACKS TEACHER SET

P8903\$68.85★

Includes 1 student set and a disk of lesson plans.

NOTE KNACKS FULL CLASSROOM SET

P8904\$249.95★

Includes 5 Student Sets and a set of lesson plans.



P8904

NOTE KNACKS EXTENSION SET

P8908\$89.95★

Ready to take the next step? These notation blocks are proportionally correct for advanced rhythms!

Included are: One dotted whole note, 2 dotted half notes, 4 dotted quarter notes, 4 dotted eighths, 2 quarter triplets, 4 eighth triplets, 4 three quarter notes beamed, 4 two beamed eighths, 4 four beamed sixteenths, 4 one eighth beamed to two sixteenths, 4 two sixteenths beamed to one eighth, 2 one dotted eighth beamed to one sixteenth, A 6/8, a 9/8 and a 12/8 time signature frames.



P8908

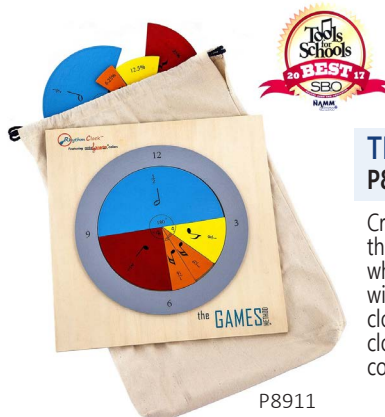

P8911

THE RHYTHM CLOCK

P8911\$44.75★

Created by Joseph Vinceli from The Games Method, the Rhythm Clock includes 31 pieces representing whole, half, quarter, eighth, and sixteenth notes with their corresponding rests on the back. The clock also shows degrees, percentages, fractions, clock positions, and directions. A great way to make connections between many subjects!

MOVEMENT PROPS FROM BEAR PAW CREEK

Rainbow Scarf Sets of 6

contains six 27" square scarves.

P9019 PASTEL\$21.95★

(lavender, medium blue, lime green, yellow, peach, and pink)

P9020

P9020 RAINBOW\$21.95★

(red, orange, yellow, kelly green, royal blue, and purple)



P9010 25" SCARF KIT\$69.95★

Set of 24. 25" square scarves with insert and bag; 2 of each in the following colors: purple, lavender, royal blue, medium blue, kelly green, lime green, yellow, orange, red, pink, black, and white.



P9011 36" SCARF KIT\$119.95★

Set of 24. 36" square scarves with insert and bag; 2 of each in the following colors: purple, lavender, royal blue, medium blue, kelly green, lime green, yellow, orange, red, pink, black and white.

P9012 50" SCARF KIT\$139.95★

Set of 24. 54" square scarves with insert and bag; 2 of each in the following colors: purple, lavender, royal blue, medium blue, kelly green, lime green, yellow, orange, red, pink, black, and white.

P9015 CANOPIES\$35.00★

One ea. 9' x 9' Canopy available in the following colors: royal blue, red or white. Includes insert and bag

P9016 PATRIOTIC CANOPY KIT\$90.00★

Three ea. 9' x 9' canopies in red, white and royal blue. Includes insert and bag.

P9017 COLLABORATION KIT\$55.00★

Six 54" rainbow colored scarves.



The musical instruments in our catalog are not toys. They are intended for use by adults and children with adult supervision. Unless otherwise stated, the instruments are not recommended for children under 3 years of age.

MY MANY COLORED DAYS

P9021 GROUP KIT\$82.00★

P9022 INDIVIDUAL KIT\$47.95★

This multi-awarded kit, centered on the famous book by Dr. Seuss, My Many Colored Days, is used to reinforce color recognition, reading books, identifying and exploring mood, creating movement to match music, and starting and stopping (motor control). Kit Contains:

- The board book, My Many Colored Days by Dr. Seuss
- 20 (Group Kit) or 10 (Individual Kit) durable 25" square washable nylon scarves with 2 (Group Kit) or 1 (Individual Kit) of each of the following colors - purple, royal blue, gray, black, orange, red, kelly green, brown, pink, and yellow.
- IDEAS Colors Music Download with short sound color segments, then entire pieces, all chosen for mood and movement
- Reusable storage bag with handles



P9021



P9024

P9022

† Not Illustrated

P9018 IDEAS COMBINATION KIT\$179.95★

Set of three canopies, six 54" inch rainbow colored scarves, twelve 27" rainbow colored scarves, and IDEAS CD I.

★ Starred items already discounted, not subject to further discounts — NET PRICES

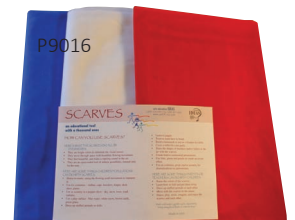

P9016

Educator or Educational institution status is required for discounted pricing featured in this catalog.

ZWUBBER BANDS

7-foot-long stretch bands that come in rainbow colors; red, orange, yellow, green, blue, and purple in rainbow order. Each 7 foot band is closed with a light-weight buckle. This allows you to increase the size of your stretch band simply by adding on another 7 foot stretch band! You now can go from one class to the next class, adding or removing a band as you need. You can even separate the bands into small groups if need be, quickly and easily during class. They can be used not only in a circle but in a straight line as well!



P8800

P8800	Single 7' Long Zwubber Band\$22.50★
P8801	Four 7' Long Zwubber Bands with Bag\$93.00★
P8802	Six 7' Long Zwubber Bands with Bag\$138.00★

HAPPY PUPPET SET

Have fun for hours playing with these plush Happy Kids Hand Puppets. Each of these delightful hand puppets has a working mouth with a huge smile, embroidered features and durable, sewn-on clothing. They're perfect for school classrooms, daycares or children's groups. Everyone can be a puppet master! Put a smiling puppet on your hand and put on a puppet show! Plush. (8 pcs. per set) 14". Spot clean only.



P9030

P9030	Happy Puppet Set\$49.95★
-------	------------------	---------------

★ Starred items already discounted, not subject to further discounts — NET PRICES

PERIPOLE® "I'M A STAR" MICROPHONE

P7009	\$6.50..... \$5.20
-------	--------------------

One wood microphone. Students are encouraged and inspired to sing songs by playing with a "Let's Pretend" microphone. Much echo singing, pitch-matching and dramatic play can be motivated. Teaching guide included.



P9001	IDEAS MUSIC PRIMARY CD\$10.00★
-------	------------------------	---------------

Sailing, Tortoise & Hare, Follow Me, Rainbows, and Pudding & Popcorn

P9002	IDEAS MUSIC INTERMEDIATE CD\$10.00★
-------	-----------------------------	---------------

Serenade, Echo Playground, Jazz Triad, Wind Song, and Contrasts

P9004	IDEAS MUSIC CDI\$15.00★
-------	-----------------	---------------

(Includes all 10 pieces of the Primary and Intermediate CDs) Sailing, Tortoise & Hare, Follow Me, Rainbows, Pudding & Popcorn, Serenade, Echo Playground, Jazz Triad, Wind Song and Contrasts

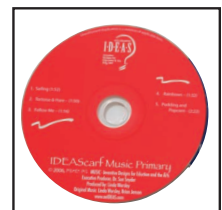

Register for educator account at Peripole.com



Peripole's Guide To The Ukulele

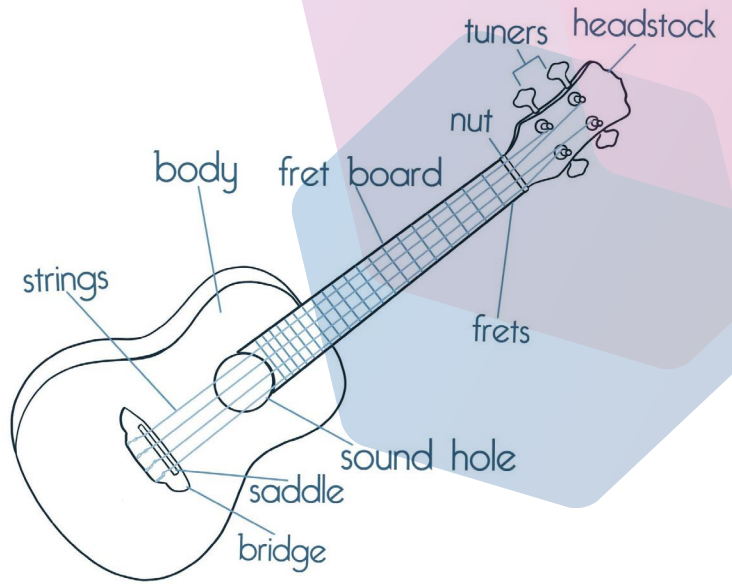

WHY ADD UKULELE TO YOUR MUSIC PROGRAM?

- The ukulele is easy to learn with a high return in musicality for effort provided. Four strings make chording much easier than guitar and children will want to advance their musical skills and knowledge of music theory so they can take on increasingly more complex songs.
- Ukulele inspires kids to want to learn music! They can learn most contemporary songs on it and they want to learn to sing well with it. It is a very social instrument and can be a pathway to social engagement even from home. It is highly portable and easily shared. Not only that, but in comparison to other instruments the ukulele is relatively inexpensive.
- The Ukulele works well with your existing ensemble of elementary instruments. Easily integrated into your presentations along with movement, Orff instruments, percussion, and recorder.
- Skills learned and trained by ukulele practice are transferable to other string instruments. Learning chord formation, strumming technique and rhythm, and training fingers to create chords will be skills that can apply to other instruments if your students choose to branch out! Not just guitar, but also mandolin, banjo, bass and even orchestral instruments like violin.

SKILLS LEARNED FROM A UKULELE PROGRAM

- Music theory
- Reading of tab and traditional notation
- Two hand playing method
- Rhythm and strumming
- Chord formation and theory
- Vocal advancement when paired with ukulele

Register for educator account at Peripole.com or contact us for educator discounts.

UKULELE SIZES AND TUNING

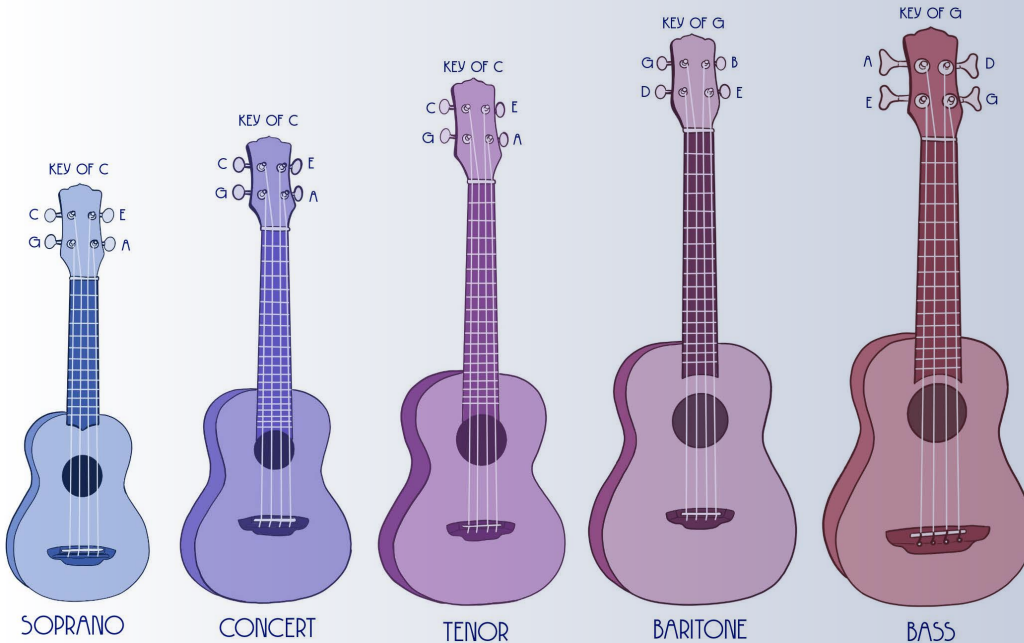

Choosing a Ukulele Type – Soprano, Concert, and Tenor all use reentrant tuning (Hi-G/C/E/A), sometimes with low G on 4th string. These 3 all have identical pitches. Baritone is D/G/B/E (like 1st 4 strings of a guitar) and bass is E/A/D/G (like a bass guitar)

Soprano – Chosen for many elementary sets. Smallest scale for smaller hands. Playable by many adults. Typically has 12 frets.

Concert – Built on slightly larger scale than soprano, typically has 18 frets. Good choice for older upper elementary grades and up to adult. More frets allow for development of more advanced skills.

Tenor – Built on slightly larger scale than concert. Typically has 18 frets. Good choice for teens and adults with medium to larger hands.

Baritone – Because of different tuning requires different fingering. Built to a larger scale. Good bridge instrument to guitar as they are tuned the same.

Bass – The newest member of the ukulele family. Tuned and played the same as a full bass. Enriches the sound with bass lines. Compact size makes it great for travel and good for new learners of the bass.



**Peripole®
Classic™
UKULELE**
BY ENYA



Peripole is proud to announce our newest innovation in ukuleles:

The Peripole® Classic™ Ukulele by Enya

These New Ukuleles, available exclusively from Peripole, offer an unparalleled combination of quality, price, and features while including a complete kit of quality accessories!

P7701	Soprano Peripole® Classic™ Ukulele	\$80.95 \$64.76
P7702	Concert Peripole® Classic™ Ukulele	\$85.95 \$68.76
P7703	Tenor Peripole® Classic™ Ukulele	\$90.95 \$72.76

UKULELE FEATURES:

- Great Action, Intonation, and Tuning Retention!
- No Sharp frets at sides of neck
- Closed geared tuners to keep out dust
- Factory installed strap buttons on all instruments
- Beautiful sound!
- Includes Enrichment Kit!
- Mahogany wood

NEW!
A revolution in Quality, Price and Accessories!

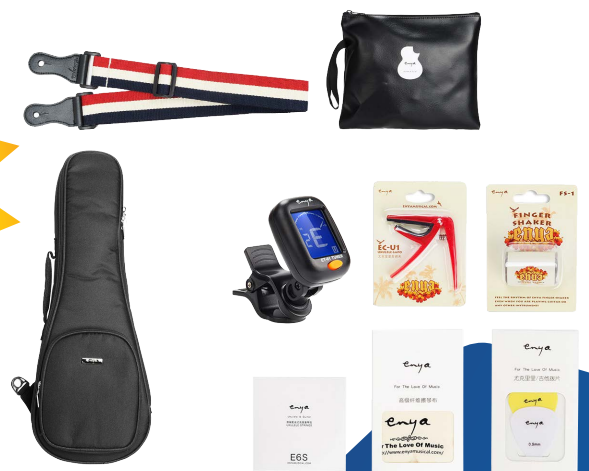

ENYA UKULELE ENRICHMENT KIT
P7790 ~~\$19.95~~... **\$15.96**
gig bag not included

Educator or Educational institution status is required for discounted pricing featured in this catalog.

ENRICHMENT KIT FREE WITH EACH INSTRUMENT:

- Padded gig bag with zipper pocket to hold accessories
- Strap
- Vibrational digital-chromatic tuner
- Capo
- Extra set of strings
- Polishing cloth
- Finger shaker for strumming hand

ENYA SOLID WOOD UKULELES



P7710

ENYA SOLID MAHOGANY TOP UKULELE

- P7710 Natural ~~-\$80.99...~~ **\$72.89**
- P7711 Blue Stain ~~-\$80.99...~~ **\$72.89**

This concert ukulele features a solid mahogany top with laminated mahogany back and sides. The solid top emits a bright, warm mahogany sound.



P7713

ENYA ALL SOLID MAHOGANY UKULELE

These Ukuleles feature an all solid mahogany body including top, sides, back, and neck, which provides a much better sustain, richer tone, and more volume than laminated woods.

P7714

- P7712 Enya Solid Mahogany Concert Natural Ukulele ~~\$124.99....~~ **\$112.49**
- P7713 Enya Solid Mahogany Concert Blue Ukulele ~~\$124.99....~~ **\$112.49**
- P7714 Enya Solid Mahogany Tenor Natural Ukulele ~~\$145.99....~~ **\$131.39**
- P7715 Enya Solid Mahogany Tenor Blue Ukulele ~~\$145.99....~~ **\$131.39**

★ Starred items already discounted, not subject to further discounts — NET PRICES

ENYA ALL SOLID GLOSSY MAHOGANY UKULELES

These professional level ukuleles feature an all-solid mahogany top, back, and sides as well as upgraded tuning gears, high glossy finish, and beautiful abalone inlay. Includes premium padded gig bag.



P7720



P7721

- P7720 All Solid Mahogany Concert Ukulele**\$229.99★**
- P7721 All Solid Mahogany Tenor Ukulele**\$259.99★**
- P7724 Black All Solid Mahogany Concert Ukulele**\$229.99★**
- P7725 Black All Solid Mahogany Tenor Ukulele**\$259.99★**

Register for educator account at Peripole.com



Educator or Educational institution status is required for discounted pricing featured in this catalog.

P7724

ENYA ALL SOLID MANGO WOOD UKULELES

These hand-made, solid mango wood ukuleles have a warm sound and sonic clarity throughout a wide tonal spectrum. With gold die-cast tuning gears, an ebony fretboard, maple inlays, Nubone nut and saddle. Available with preamp. Includes premium gig bag.

- P7745 All Solid Mango Wood Concert Ukulele**\$459.99★**
- P7746 All Solid Mango Wood Tenor Ukulele**\$489.99★**



The musical instruments in our catalog are not toys. They are intended for use by adults and children with adult supervision. Unless otherwise stated, the instruments are not recommended for children under 3 years of age.



P7745

Made of carbon fiber composite, innovated for beautiful sound and intonation, the Enya Nova U series is the next generation of ukulele! Nova U Ukuleles deliver durability, weather resistance and a sleek, beautiful look. Like all Enya ukuleles, they include pre-installed strap buttons, a case, and accessory kit.

ACOUSTIC PLUS

The groundbreaking Acoustic Plus creates chorus, reverb, and delay effects from the instrument's vibrations with no external effects or amplification. When amplified, these effects are amplified as well.



ENYA NOVA U CONCERT UKULELES

P7501	White Nova U Concert Ukulele	\$89.99.....	\$80.99
P7502	Pink Nova U Concert Ukulele	\$89.99.....	\$80.99
P7503	Orange Nova U Concert Ukulele	\$89.99.....	\$80.99
P7504	Blue Nova U Concert Ukulele	\$89.99.....	\$80.99
P7505	Black Nova U Concert Ukulele	\$89.99.....	\$80.99
P7511	Red Nova U Concert Ukulele	\$89.99.....	\$80.99

* Easy To Sanitize!

ENYA NOVA U MINI SOPRANO UKULELES

P7910	Black Enya Nova U Mini Soprano Ukulele\$56.99★
P7911	White Enya Nova U Mini Soprano Ukulele\$56.99★
P7912	Blue Enya Nova U Mini Soprano Ukulele\$56.99★

* Easy To Sanitize!



ENYA NOVA U PRO TENOR UKULELES

P7920	White Nova U Pro Tenor Ukulele	\$139.99.....	\$125.99
P7921	Black Nova U Pro Tenor Ukulele	\$139.99.....	\$125.99
P7930	White Nova U Pro Tenor Ukulele w/Acoustic Plus	\$229.99.....	\$209.99
P7931	Black Nova U Pro Tenor Ukulele w/Acoustic Plus	\$229.99.....	\$209.99



ENYA FEATHER THIN BODY ALL SOLID MAHOGANY ACOUSTIC+ UKULELES

P7760	Brown Thin Body Feather Tenor Ukulele	\$599.99.....	\$539.99
P7761	Blue Thin Body Feather Tenor Ukulele	\$599.99.....	\$539.99

NEW!

ENYA TAIMANE MOON ALL SOLID MAHOGANY UKULELES

P7755	Brown Taimane Tenor Ukulele	\$399.99.....	\$359.99
P7756	Brown Taimane Tenor Ukulele w/Acoustic+	\$499.99.....	\$449.99
P7757	Blue Taimane Tenor Ukulele	\$399.99.....	\$359.99
P7758	Blue Taimane Tenor Ukulele w/Acoustic+	\$499.99.....	\$449.99

NEW!



UKULELE CLASSROOM SETS

Set of Peripole® Classic™ Ukuleles by Enya. These fantastic ukuleles are perfect for new players and ideal for the classroom setting, tuning retention, intonation, action and playability.

Each ukulele in the set includes: gig bag, strap, tuner, picks, capo, extra set of strings, finger shaker, pre-installed two-point strap buttons and polishing cloth.

P7890	10	Soprano	\$809.50 \$631.41
P7891	16	Soprano	\$1,295.20 \$1,010.26
P7892	24	Soprano	\$1,942.80 \$1,476.53
P7895	10	Concert	\$859.50 \$670.41
P7896	16	Concert	\$1,289.25 \$1,072.66
P7897	24	Concert	\$2,062.80 \$1,567.73



ENYA MINI SOPRANO & CONCERT NOVA U UKULELE

These sets of Enya Nova U Ukuleles are the perfect safe solution for your classroom! Made from a carbon fiber blend, these ukuleles are fully sanitizable with non-porous surfaces! Each ukulele in the set comes with a semi-hard gig bag and accessory kit.

P7900	10	Soprano Nova U	\$590.00 \$555.65
P7901	16	Soprano Nova U	\$944.00 \$889.04
P7902	24	Soprano Nova U	\$1,416.00 \$1,299.37
P7903	10	Concert Nova U	\$899.90 \$789.66
P7904	16	Concert Nova U	\$1,439.84 \$1263.44
P7905	24	Concert Nova U	\$2,159.76 \$1846.57



Note: Nova ukulele color available upon request. If no color is requested, set default color is black or subject to in-stock availability. See color options on pg 55.

Peripole Ukulele Sets are pre-discounted using all available educator and volume discounts. No further discounts can be applied.

CREATE YOUR OWN CLASSROOM SETS AND SAVE!

Peripole now offers quantity discounts on quantities purchased of all brands of ukuleles that we sell! With this special classroom discount, you can mix and match your ukulele models to create the ideal set for your school. **Discount is determined by quantity of ukuleles purchased.**

This same discount also applies to all ukulele accessories purchased with your classroom sets. Accessories **must be** purchased with ukulele order to qualify for discount rate. No purchase minimum on accessories when minimum ukulele purchase is met. These accessories include cases, gig bags, strings, tuners, picks, capos, stands and more!

For example, if you buy 10 ukuleles for your classroom you will receive 2.5% off your total purchase of ukuleles and accessories. Get your ukulele program started today!

QUANTITY PURCHASED	DISCOUNT
10-17	2.5%
18-29	5.0%
30 - 39	7.5%
40 OR MORE	10%

Peripole is proud to be an Educational Distributor for the **Luna** line of high quality ukuleles and guitars. Most Luna Ukuleles come equipped with Aquila Strings, some of the best on the market, and have excellent tuning retention, intonation and a rich sound. They also have beautiful designs, crafting, and details.

Luna's major series include the **Vintage Series**, with an excellent combination of value and quality; the **Tattoo Series**, featuring beautiful designs with gig bags included; and the **High Tide Series**, featuring exotic hardwoods, deluxe appointments, exacting crafting, and gig bags.

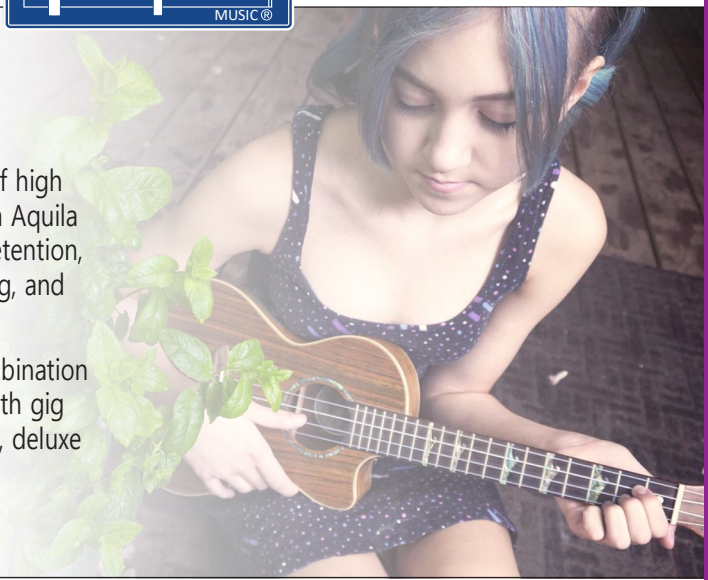

VINTAGE SERIES

The luna Vintage Series combine excellent quality with value pricing. Their classic etched solar sound hole decoration, Aquila strings, and a variety of styles makes this series a popular teachers choice. All Vintage Models have walnut bridges and fretboards.

†P7301	Vintage Mahogany Soprano - Red Satin\$69.00★
P7302	Vintage Mahogany Soprano - Black Satin\$69.00★
P7304	Vintage Mahogany Pineapple Soprano\$69.00★
P7306	Vintage Mahogany Soprano with Pre-Amp\$99.00★
P7309	Vintage Mahogany Concert with Pre-Amp\$129.00★
†P7320	Vintage Mahogany Concert Pack Includes Gig Bag, Tuner, and Chord Chart\$139.00★
P7321	Vintage Mahogany Tenor\$129.00★
P7323	Vintage Mahogany Baritone\$179.00★
P7324	Vintage Mahogany Baritone - with Pre-Amp\$199.00★

† Not Illustrated



P7320

All of the Tattoo Series ukuleles include:

- Mahogany back and sides
- Walnut fretboard and bridges
- Aquila strings
- Laser etched design
- Gig bag

Extracting design ideas from traditional monochrome Pacific Island body ornamentation, these ukuleles look and sound stunningly beautiful. The **TATTOO** series designs are primarily based on waves and sharks teeth which are also echoed as fret markers. The **HONU** design is based on a stylized Hawaiian turtle (honu). Fret markers on this instrument are also stylized sharks teeth.

★ Starred items already discounted, not subject to further discounts — NET PRICES

LUNA TATTOO SERIES

P7070	Soprano Tattoo Pineapple\$109.00★
P7071	Soprano Honu\$129.00★
† P7072	Concert Tattoo\$129.00★
P7073	Concert Tattoo Acoustic/Electric With Cutaway\$199.00★
† P7074	Tenor Tattoo\$169.00★



Educator or Educational institution status is required for discounted pricing featured in this catalog.



ZIRICOTE WOOD SERIES

† P7375	Luna Ziricote Soprano Ukulele\$179.00★
† P7373	Luna Ziricote Concert Ukulele\$189.00★
P7376	Luna Ziricote Tenor Ukulele\$209.00★

Ziricote offers a captivating color scheme and unique wood grain pattern, which consists of a majority dark brown shade and grain lines that reflect spider webs or marbled swirls in a light gloss layer. Expect warm, boomy sounds with sparkly highs.



P7376

★ Starred items already discounted, not subject to further discounts — NET PRICES

LUNA BAMBOO SERIES

† P7360	Luna Bamboo Soprano\$129.00★
† P7361	Luna Bamboo Concert\$139.00★
P7362	Luna Bamboo Tenor\$159.00★

Bamboo has a crisp, vibrant tone with amazing volume projection that any player can appreciate. Built with a mahogany neck, walnut fretboard and bridge, and stunning pear moon inlays. Laser etched bamboo leaf sound hole design. Includes gig bag.



P7362

HIGH TIDE SERIES

Luna's **HIGH TIDE** series uses three of the finest tone woods to create a diversity of sounds within this high quality series. All High Tide Ukuleles have abalone fret markers and full moon themes in a stunning design with decorative bindings.

Most importantly, the sound and intonation of these fine ukuleles is rich and vibrant. Some models have pre-amps for electric amplification, but also have exquisite acoustic sound. With so many models to choose from, these are great ukuleles for all players from beginners to experienced musicians.

All models have walnut bridges and fretboards and include a gig bag.

P7370	Luna High Tide Exotic Mahogany Soprano\$179.00★
P7371	Luna High Tide Exotic Mahogany Concert\$249.00★
P7372	Luna High Tide Exotic Mahogany Tenor\$199.00★
P7045	Luna High Tide Soprano Koa w/pre-amp\$249.00★
† P7046	Luna High Tide Tenor Koa w/pre-amp\$399.00★
† P7076	Luna High Tide Concert Koa w/pre-amp\$399.00★
P7077	Luna High Tide Tenor Ovangkol w/pre-amp\$319.00★
P7079	Luna High Tide Baritone Koa Wood w/pre-amp\$419.00★



P7370



P7371



P7372



P7079



P7077



P7076



Educator or Educational institution status is required for discounted pricing featured in this catalog.

The **HIGH TIDE** series now comes in a three amazing tone woods!

EXOTIC MAHOGANY: Has a unique tonal clarity and open brilliance where the "punchy" mid-tones really shine.

OVANGKOL: Fully balanced with a pronounced mid-range, sparkling trebles and highs and deep lows. Well rounded for all playing styles.

KOA: Sweet, mellow and warm sound that is direct with less overtone, but open sustain. Very mid-ranged and balanced.

SPECIAL LUNA CONCERT MODELS

All models have walnut bridges and fretboards. Gig bags included.

LUNA STARRY NIGHT CONCERT UKULELE

P7352\$199.00★

Features the famous artwork of Vincent Van Gogh on a mahogany construction instrument.



P7352

LUNA GREAT WAVE CONCERT UKULELE

P7351\$169.00★

Features the art of the great Japanese artist, Hokusai on a mahogany construction instrument with cutaway.



P7351

LUNA ULU BANJOLELE

P7068\$279.00★

Ukulele size and tuning with a real drum head banjo style body. Aquila strings.



P7068

LUNA BASS UKULELES

These innovative new members of the ukulele ensemble feature deluxe closed tuners, flatwound strings, baritone body, Luna preamp for electric amplification, mahogany neck, walnut fingerboard, and 20.2 inch scale. One octave above bass guitar. Gig bag included.

P7090 **Tattoo Bass**\$219.00★

Decorative traditional Hawaiian monochrome patterns, spruce top, mahogany back and sides, and satin finish.

- Equipped with Aquila Thundergut Strings
- Electronic preamp
- Finest quality
- Same octave as bass guitar
- Walnut fretboard and bridge
- Gig bag Included

LUNA BARI-BASSES

P7097 **Quilted Ash**\$369.00★

P7098 **Koa**\$369.00★



P7090

P7097

P7098

OTHER UKULELES

DEAN CONCERT SPRUCE

P7310\$139.00★

Limited Quantity

Features a spruce top on a mahogany body with mahogany neck and rosewood fretboard. This handsome and great sounding instrument has a maple and padauk binding and sound hole rosette. Open gear tuners, quality strings, and Celtic style art, finish this fine ukulele.



P7310

DEAN DELUXE KOA WOOD CONCERT UKULELE

P7312\$219.00★

Limited Quantity

Features koa back and sides, mahogany neck, 15 inch scale, 20 frets, rosewood fretboard and white mother of pearl Celtic inlays.

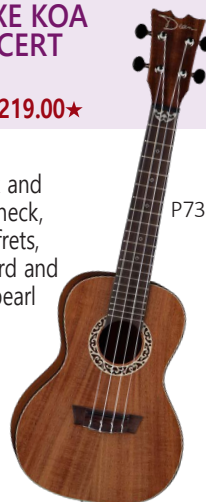

P7312

DIAMOND HEAD UKULELES

P7054 **Soprano**\$48.50★

A perfect combination of quality and affordability, the Diamond Head Ukulele has a carefully crafted mahogany body and neck; and reliable, gold-plated, guitar style, geared tuners with white plastic buttons. Accurate frets, gig bag, and professional set up makes these fine ukuleles a fantastic value.



P7054



The musical instruments in our catalog are not toys. They are intended for use by adults and children with adult supervision. Unless otherwise stated, the instruments are not recommended for children under 3 years of age.

GUITARS AND UKULELE ACCESSORIES

PADDED UKULELE GIG BAGS

Gig Bags for All Ukulele Sizes!

P7050	Soprano	\$26.95.....	\$21.56
P7051	Concert	\$26.95.....	\$21.56
P7052	Tenor	\$26.95.....	\$21.56
P7053	Baritone	\$49.95.....	\$39.96



UKE STRAPZ

P7190	\$15.00.....	\$12.00
-------	--------------	---------

This strap is for the player that does not have strap buttons on their ukulele. It wraps around the body and head of the ukulele for comfortable playing. Uke Strapz will fit most soprano, concert or tenor ukulele and even a banjolele. It is made of adjustable nylon webbing, polycord and an easily detachable clip.



LUNA LIGHTWEIGHT UKULELE CASES

Features lightweight durable construction and polystyrene core cushioning with 5mm outer foam padding. Water resistant material with plush interior. Two-way zip closure and detachable shoulder strap.

P7040	Soprano	\$85.00★
P7041	Concert	\$85.00★
P7042	Tenor	\$99.00★
P7048	Bass/Baritone	\$99.00★

STRAPS

P7140	Metal Strap Buttons	\$4.95★
P7141	Classical Hook Style Strap	\$9.29★
P7142	Basic Guitar Strap	\$9.95...	\$7.96
P7144	Deluxe Guitar Strap	\$14.95...	\$11.96
P7786	Leather Guitar Strap	\$14.99★
P7139	2-Point Ukulele Strap	\$12.95...	\$10.36

MUSEDO STYLE



D'ADDARIO TRI-ACTION STYLE



D'ADDARIO PRO STYLE



CAPOS

P7131	Musedo Capo for Acoustic or Electric Guitars	\$16.99★
P7132	Musedo Capo for Folk Guitars	\$16.99★
P7133	Musedo Capo for Ukuleles	\$16.99★
P7134	Musedo Capo for Acoustic or Classical Guitars	\$16.99★
P7105	D'Addario Tri-Action Guitar Capo	\$25.99★
P7106	D'Addario Tri-Action Ukulele Capo	\$22.99★
P7107	D'Addario Pro Guitar Capo	\$21.99★
P7108	D'Addario Pro Ukulele Capo	\$17.99★
P7109	D'Addario Pro Classical Guitar Capo	\$21.99★

SMART TUNER

P7784	\$49.99★
-------	-------	----------



Simply place the tuning bracket on the instruments tuning peg and pluck the corresponding string. The Smart Tuner will quickly and accurately move the tuning peg and tune the instrument. You can set the tuner to auto or manually set the notes.

- For guitars and ukuleles
- Auto, semi-auto, and manual settings
- Low-G ukulele setting available
- Tunes by vibration for precise and accurate tuning regardless of external noise
- Built in beep metronome
- Rechargeable battery



INSTRUMENT HUMIDIFIERS

Humidifiers protect your instrument even in the driest conditions, guarding against cracks, warped necks, and shrinkage. Suspended by the strings, the humidifier releases moisture evenly and slowly.

P7168	Acoustic Guitar Humidifier	\$12.00.....	\$9.60
P7169	Guitar Pro Humidifier	\$20.80.....	\$16.64
P7170	Ukulele Pro Humidifier	\$18.70.....	\$14.96
P7171	Small Instrument Case Humidifier	\$11.55.....	\$9.24



TUNERS

P7067	Snark Vibrational Clamp-On Ukulele Tuner	\$17.99★
†P7180	Snark Vibrational Clamp-On All Instrument Tuner	\$21.95★
†P7182	Snark Vibrational Clamp-On Tuner for Guitar, Bass, & Violin	\$17.99★
†P7181	Cherub 3 in One Tuner and Metronome	\$24.99★
P7175	Vibrational Clamp-on Digital Tuner - chromatic, guitar, violin, & ukulele	\$9.99.....	\$7.99



P7175

P7067

GUITARS AND UKULELE ACCESORIES

Great for Ukulele!

P7173



DELUXE DREADNOUGHT AND ACOUSTIC GUITAR GIG BAG

P7270 \$49.95... \$39.96

External pocket.
Fits most dreadnought and cutaway models.

P7270



DELUXE GIG BAG FOR CLASSICAL GUITARS

P7269 \$49.95... \$39.96

External Pocket.
Fits most classical guitars

P7269



PICKS

P7065	Felt Ukulele Picks—4 Pack	\$9.95..... \$7.96
P7173	Peripole Leather Pick	\$2.00..... \$1.60
P7174	Peripole Leather Picks—10 Pack	\$16.00..... \$12.80
P7120	12 Pack Thin Tortoise Shell Picks	\$5.95..... \$4.76
P7121	12 Pack Medium Tortoise Shell Picks	\$5.95..... \$4.76
P7122	12 Pack Heavy Tortoise Shell Picks	\$5.95..... \$4.76

HARD CASES FOR GUITARS

P7251\$149.95★

For Dreadnought, Nexbody, and Cutaway Guitars

P7252\$149.95★

For Classical Guitars

Plush-lined

P7251



DELUXE POLYFOAM PLUSH-LINED GUITAR CASE

P7255\$149.95★

- Plush-lined
- Fits most dreadnought and cutaway models.
- Light weight

P7255



ELECTRIC GUITAR GIG BAG

P7273\$49.95★

External pocket.
Fits most electric guitars

P7273



ELECTRIC BASS GIG BAG

P7274\$49.95★

External Pocket.
Fits most electric bass guitars

P7264



NEW!



P7066 \$19.95..... \$15.96
Folding Ukulele Stand

P7066



† Not Illustrated

GUITAR & BASS STRINGS

NEW!

†P7110	D'Addario Classical Strings—Normal Tension	...\$12.95★
†P7165	D'Addario Phosphor Bronze Strings— Extra Light	...\$8.99★
†P7166	D'Addario Phosphor Bronze Strings—Light	...\$8.99★
†P7167	D'Addario Phosphor Bronze Strings—Medium	...\$8.99★
†P7155	Aquila Alabastro Guitar Strings—Light	...\$11.50★
†P7156	Aquila Alabastro Guitar Strings—Normal	...\$11.50★
†P7157	Aquila Alabastro Guitar Strings—Superior	...\$11.50★
†P7158	Aquila Perla Guitar Strings—Normal	...\$11.50★
†P7159	Aquila Perla Guitar Strings—Superior	...\$11.50★
†P7160	Aquila Ambra 2000 Guitar Strings W/Silver Plated Bass String Windings	...\$11.50★
†P7440	D'Addario NYXL Super Light Electric Guitar Strings	...\$12.99★
†P7441	D'Addario NYXL Light Electric Guitar Strings	...\$12.99★
†P7442	D'Addario NYXL Medium Electric Guitar Strings	...\$12.99★
†P7443	D'Addario NYXL Heavy Electric Guitar Strings	...\$12.99★
†P7444	D'Addario NYXL Light Electric Long Scale Bass Strings	...\$29.99★
†P7445	D'Addario NYXL Med Electric Long Scale Bass Strings	...\$29.99★
†P7446	D'Addario NYXL Heavy Electric Long Scale Bass Strings	...\$29.99★

UKULELE STRINGS

†P7150	Aquila Nylgut Ukulele Strings—Soprano	...\$6.95★
†P7151	Aquila Nylgut Ukulele Strings—Soprano Low G	...\$7.95★
†P7152	Aquila Nylgut Ukulele Strings—Concert	...\$6.95★
†P7148	Aquila Nylgut Ukulele Strings—Concert Low G	...\$7.95★
†P7153	Aquila Nylgut Ukulele Strings—Tenor	...\$6.95★
†P7149	Aquila Nylgut Ukulele Strings—Tenor Low G	...\$7.95★
†P7154	Aquila Nylgut Ukulele Strings—Baritone	...\$7.95★
†P7147	Aquila Nylgut Ukulele Strings—Banjolele	...\$7.25★
P7793	Enya Fluorocarbon Strings (Fits Soprano, Concert, and Tenor)	...\$9.95★
†P7787	Enya Fluorocarbon Low G String (Single String)	\$5.99... \$5.09
†P7788	Enya Wound Low G String (Single String)	\$5.99... \$5.09
†P7356	Aquila Rainbow Kids Strings (In Boomwhacker Colors)	...\$8.99★



QUALITY CLASSROOM GUITARS

Our classroom guitars are the kind of instrument that beginning and intermediate level musicians are proud to play. The sound is great and so is the action and intonation. The kind of instrument that makes you love to play and practice!

SIZED CLASSICAL GUITARS

† P7103	3/4 Size Natural 628 mm Scale	\$179.95	\$152.96
P7104	4/4 Size Natural Full Scale	\$192.35	\$163.50
† P7143	Guitar Foot Stool	\$19.95	\$15.96
P7115	Guitar Stand	\$35.95	\$28.76

† Not Illustrated

These classical guitar models are scaled to exact dimensions in fingerboard scale, bracing and acoustic tolerances, and for correct pitch regardless of size. The sizing system establishes full size (4/4) as the adult size and the smaller (3/4) guitar for smaller players. Both sizes of the guitar are constructed of the same high quality materials, featuring a top made of spruce naturally finished, real mahogany back and sides, adjustable tuning machines with white pearl buttons.



P7104

DREADNOUGHT

P7200 Dreadnought ~~\$219.95~~... **\$197.96**

Dreadnought guitars have the deep, round, figure-8 shape that have become the standard of bluegrass, folk, and other genres. They offer a deep, full sound and are generally larger than other guitar body styles. Steel strings.

- Spruce top
- Nato back and sides
- Rosewood fretboard
- Natural finish
- Chrome tuners

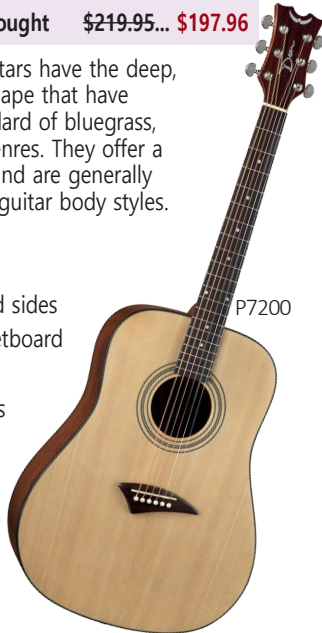

P7200

CUTAWAY

P7210 Acoustic ~~\$199.00~~... **\$179.10**

Cutaway body style has a pleasing, rounded profile that is narrow at the waist, yet broad behind the bridge creating a soundboard that offers a balanced frequency response with deep bass, clear treble, and a sweet, round midrange that projects well. The body carries the depth of a dreadnought to ensure a great level of volume. It has the feel of a small-bodied guitar yet yields impressive performance. The deep cutaway allows easy access to the instruments higher frets and range.

- Spruce top
- Nato back and sides
- Rosewood fretboard
- Natural finish
- Chrome tuners



P7210

 **Educator or Educational institution status is required for discounted pricing featured in this catalog.**

GUITAR KITS

CLASSICAL GUITAR KIT

P7412 ~~\$264.95~~... **\$225.21**

- Includes: gig bag, foot stool, and tuner
- Entry level full sized classical guitar
- Spruce top with gloss finish
- Nylon strings for comfort of playing.

P7412



CORT EARTH SERIES ACOUSTIC DREADNOUGHT GUITAR

P7430 ~~....\$339.99~~★

- Solid Sitka spruce top provides an ideal balance between strength and flexibility.
- Mahogany neck, back and sides. Bright yet natural with a strong and warm midrange.
- Open Pore Finish that enhances the resonance of the woods and reduces the weight of the guitar.
- Exclusive scooped surface bridge from Cort enhances sustain with greater string angle from the saddle to the body while reducing tension on the strings across the neck were less finger fatigue and improved playability.

P7430



★ Starred items already discounted, not subject to further discounts — NET PRICES

PERIPOLE IS PROUD TO BE AN EDUCATIONAL DISTRIBUTOR FOR TAKAMINE GUITARS

FEATURED CLASSICAL GUITARS

CLASSICAL GUITAR

PGC1 - NAT CLASSICAL ~~\$369.00~~..... **\$350.55**
 † PGC1CE - NAT CLASSICAL ~~\$499.00~~..... **\$474.05**

- Affordable quality
- Fan-braced select spruce top w/mahogany back & sides
- Full and balanced sound
- Dovetail neck joint
- Rosewood fingerboard
- Inlaid rosette, gloss finish
- Chrome tuners w/pearl buttons
- Scale: 25.6"; nut width 2"
- Bridge: Rosewood with composite synthetic bone saddle



PGC1-NAT

DELUXE CLASSICAL GUITAR

PGC3 - NAT CLASSICAL ~~\$479.00~~..... **\$455.05**
 † PGC3CE - NAT CLASSICAL ~~\$599.00~~..... **\$569.05**

- Deluxe guitar
- Solid spruce top
- Rich, resonant sound
- Other features same as PGC1-NAT Classical



PGC3-NAT

Left Handed Models Available.
Call For More Info.



WABI SABI GRAND CONCERT GUITAR

P7423**\$399.00★**

These guitars are constructed with aesthetically imperfect tops that sound the same as A grade spruce tops so that the overall effect is asymmetric beauty and clear resonant tone at an affordable price! Made with a solid spruce top and A/E for amplification.

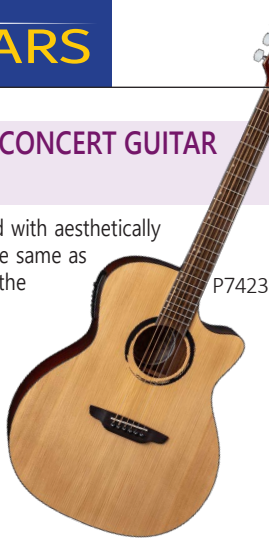

P7423

LUNA SHORT SCALE TRIBAL BASS

P7401**\$469.00★**

- Easy for smaller size hands
- Contemporary tribal sound hole art
- Spruce top
- Neck: Mahogany/Rosewood
- Luna Preamp
- Scale Length: 30", Nut width: 1 5/8"
- Finish: Matte

P7401

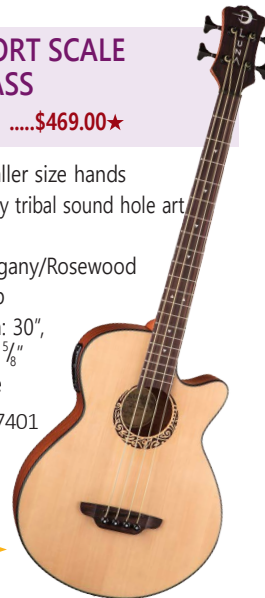

DEAN EAB-C FULL SIZE BASS

P7402**\$379.00★**

- 34" scale produces a deeper, fuller tone
- Abalone sound hole inlay and decorative binding
- Spruce top
- Body and Neck: Mahogany
- Rosewood fingerboard w/ pearl dot inlays
- PS900 preamp
- Finish: Satin
- Available in Left Handed Model. Price by request.

P7402

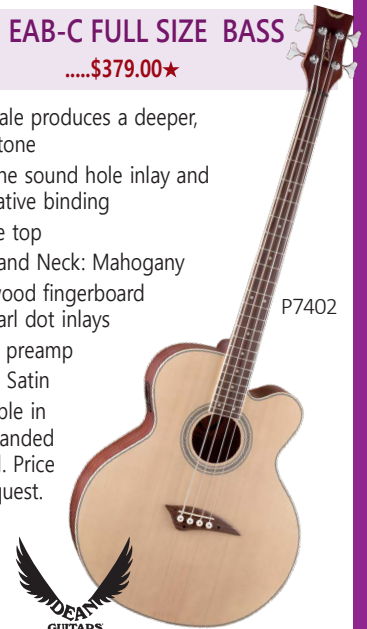

LUNA WOODLAND CEDAR NYLON STRING ACOUSTIC GUITAR W/AE

P7424**\$399.00★**

Grand concert body with a cedar top and mahogany back and sides. Laser-etched cedar leaf design and moon phase inlays along the pau ferro fretboard. Built-in tuner and AE for amplification.



P7424

NEW!

★ Starred items already discounted, not subject to further discounts — NET PRICES



Guitar Accessories pages 60-61



The musical instruments in our catalog are not toys. They are intended for use by adults and children with adult supervision. Unless otherwise stated, the instruments are not recommended for children under 3 years of age.

ELECTRIC GUITARS

ENYA X4 CARBON FIBER ACOUSTIC PLUS GUITAR

P7948	X4 Pro mini 3/4 Size	\$599.99...\$539.99
P7949	X4 Pro Full Size	\$699.99... \$629.99

New from Enya! The X4 features a carbon fiber body that is resistant to temperature change and humidity, denting, scratching, and cracking. The offset sound hole better projects the sound to the player while not sacrificing tone or volume for the audience. X4 also includes the Enya AcousticPlus® pickup system that uses a built-in actuator to enhance the string vibrations and create chorus and reverb with no external effects or amplification. Can also be plugged in to an amplifier for additional power and performance.



NEW!

NOVA GO SONIC SMART AUDIO ELECTRIC GUITARS

P7956	BLACK\$439.99★
P7957	WHITE\$439.99★

Electric guitar with 10 WATT speaker and 4 effects panel built into the actual guitar! Play electric guitar on the go, or plug into any amp for an even bigger sound!

- Acoustic carbon fiber composite 1-piece.
- 4 onboard presets: Clean, Overdrive, Crunch, and Lead. Each preset is customizable through the ENYA MUSIC APP.
- Pickup: H-H Alnico II (Neck), Alnico V (Bridge)
- Speaker: 10-Watt, Vibration-Isolated Speaker with V 5.1 Wireless Connectivity
- Controls: Long-press control button to activate or shut down, tap to switch presets. Turn volume knob to adjust. Coil-tappable, to switch the coil pickup from series to parallel.
- Battery: 7.4V USB charging system. 2 hours full charge, 10 hours battery use.



DEAN EDGE 09 4-STRING BASS

P7400\$319.00★

Features a body contoured for playing comfort. The maple neck is profiled to be fast, sleek, and easy to play. A unique Dean-design neck joint and heel along with an asymmetrical 4-bolt pattern gives you unhindered movement all the way up the 22-fret neck. A single Soapbar pickup and basswood body produces substantial growl.



NEW!

ENYA NOVA GO GUITARS

P7940	WHITE	\$189.99.... \$170.99
P7941	BLACK	\$189.99.... \$170.99
P7942	PINK	\$189.99.... \$170.99
P7943	BLUE	\$189.99.... \$170.99
P7944	PURPLE	\$189.99.... \$170.99
P7951	WHITE W/AE\$279.99★
P7952	BLACK W/AE\$279.99★
P7953	PINK W/AE\$279.99★
P7954	BLUE W/AE\$279.99★
P7955	PURPLE W/AE\$279.99★

* Easy To Sanitize!

New from Enya! The X4 features a carbon fiber body that is resistant to temperature change and humidity, denting, scratching, and cracking. The offset sound hole better projects the sound to the player while not sacrificing tone or volume for the audience. X4 also includes the Enya AcousticPlus® pickup system that uses a built-in actuator to enhance the string vibrations and create chorus and reverb with no external effects or amplification. Can also be plugged in to an amplifier for additional power and performance.



CORT X SERIES 100 DOUBLE CUTAWAY ELECTRIC GUITAR

P7431\$269.99★

- Meranti body has similar tonal characteristics to mahogany with a strong mid-midrange.
- Powersound pickups provide classic humbucker punch and tone.
- The vintage style 6-screw tremolo bridge transfers more of the strings' vibrational energy into the body.
- maple neck, Jatoba Fingerboard



NEW!

CORT G SERIES DOUBLE CUTAWAY ELECTRIC GUITAR

P7432\$249.99★

- Features a double cutaway body for classic styling, comfort, and easy access to the higher register of the fretboard.
- Pickup configuration with the 5-way switch provides a wide variety of sounds to cover virtually any musical style.
- Thinner body reduces the weight.



GUITAR CLASSROOM SETS

CREATE YOUR OWN CLASSROOM SETS AND SAVE!

Peripole now offers quantity discounts on quantities purchased of all brands of guitars that we sell! With this special classroom discount, you can mix and match your guitar models to create the ideal set for your school. **Discount is determined by quantity of guitars purchased.**

This same discount also applies to all guitar accessories purchased with your classroom sets. Accessories **must be** purchased with guitar order to qualify for discount rate. No purchase minimum on accessories when minimum guitar purchase is met. These accessories include cases, gig bags, strings, tuners, picks, capos, stands and more!

For example, if you buy 10 guitars for your classroom you will receive 2.5% off your total purchase of guitars and accessories. Get your guitar program started today!

QUANTITY PURCHASED	DISCOUNT
10-17	2.5%
18-29	5.0%
30 - 39	7.5%
40 OR MORE	10%

PRE-ASSEMBLED CLASSROOM GUITAR SETS

Our classroom guitar sets are chosen from our premium classroom guitars for the best of both worlds of quality and affordability. Choose from an array of guitars from classical or acoustic to electric to fit your program or group!

CLASSICAL GUITAR SETS

P7010	6	3/4 Size Classical	\$917.76 \$894.82
P7011	10	3/4 Size Classical	\$1529.60 \$1,491.36
P7013	6	4/4 Size Classical	\$956.46 \$956.48
P7014	10	4/4 Size Classical	\$1635.00 \$1,594.10

ELECTRIC GUITAR SETS

P7024	6	Cutaway electric guitars	\$1194.00 \$1,164.15
P7025	10	Cutaway electric guitars	\$1990.00 \$1,940.25

Need accessories to start your guitar program? Set discounts will apply to all guitar accessories purchased with custom and pre-made sets when you call to place your order!



Guitar Accessories on Pages 62-63



Educator or Educational institution status is required for discounted pricing featured in this catalog.

ACOUSTIC GUITAR SETS

P7016	6	Dreadnought	\$1187.76 \$1,158.07
P7017	10	Dreadnought	\$1979.60 \$1,930.11
P7019	6	Cutaway	\$1074.60 \$1,047.74
P7021	10	Cutaway	\$1791.00 \$1,746.23

★ Starred items already discounted, not subject to further discounts — NET PRICES

NOVA GO GUITAR SETS

P7027	6	Nova Go Acoustic	\$1074.60 \$1,047.74
P7028	10	Nova Go Acoustic	\$1791.00 \$1,746.23

Note: Nova Go color available upon request. If no color is requested, set default color is black or subject to in-stock availability. See color options on pg 66.

* Easy To Sanitize!

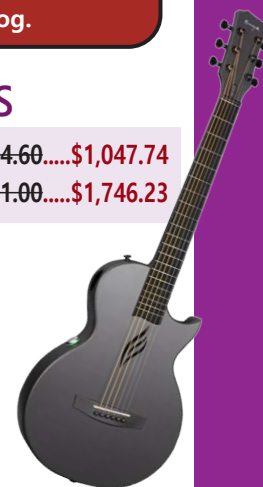

Pre-Assembled Guitar Sets are pre-discounted using all available educator and volume discounts. No further discounts can be applied.



DULCIMERS

- P7080** **Applecreek Teardrop Dulcimer Packag**\$184.95★
Laminated spruce top, back, and sides with solid maple neck and fingerboard. Includes padded case.
- P7082** **Applecreek Hourglass Dulcimer Package**\$299.95★
Laminated spruce construction. Solid maple neck and fingerboard. Includes plush-lined injection-molded case and Grover tuning machines.
- †P9300** **Dulcimer Music Book for the Beginner**\$5.95★



The musical instruments in our catalog are not toys. They are intended for use by adults and children with adult supervision. Unless otherwise stated, the instruments are not recommended for children under 3 years of age.



AMPLIFIERS

AMPLIFIERS

† P7960	Kustom KGA1 10 Watt 1x6" Combo Guitar Amplifier\$109.99★
† P7961	Kustom KGA112FX 20 Watt 2x12" Combo Guitar Amplifier\$209.99★
† P7962	Kustom KGA212FX 30 Watt 2x12" Combo Guitar Amplifier\$399.99★
P7963	Kustom KGA100 100 Watt 1x12" Combo Guitar Amplifier\$409.99★
† P7970	Kustom KXB 20 Watt 1x12" Combo Bass Amplifier\$279.99★
† P7971	Kustom KXB 100 Watt 1x15" Combo Bass Amplifier\$459.99★
P7830	NUX Digital Modeling Guitar Amplifier w/Bluetooth 8 Watt 1x 6.5"\$189.00★
† P7831	NUX Digital Modeling Guitar Amplifier w/Bluetooth 20 Watt 1x8"\$199.00★
† P7832	NUX Digital Modeling Guitar Amplifier w/Bluetooth 40 Watt 1x10"\$279.00★
† P7840	NUX Digital Modeling Bass Amplifier w/Bluetooth 50 Watt 1x6.4"\$289.00★

LUNA ACOUSTIC AMPLIFIER

P7044 **25 Watts**\$249.00★
8" Speaker and 2.5" Tweeter, CD input w/ind. volume control

Tolex covering simulates a tooled leather look. Volume, mid-range, bass, and treble controls. Chorus with speed control.



KAT 50 WATT PERCUSSION DIGITAL AMPLIFIER FOR DRUMS AND KEYBOARD

- P7950**\$299.95★
- Three 1/4" inputs for other instruments or sound sources.
 - Large carry handle for easy transport.
 - 1/8" input for external music players.
 - 19"x19.3"x19.7" 37LBS



SMART CONNECTOR

P7785\$69.99★



Wireless system utilizes UHF transmission technology, which is the foundation for its potent wireless performance. UHF brings higher transmitting power, lower latency, as well as stronger signal integrity.

- WB1 transmitter & receiver system offers 10 different frequency bands for wireless transmission.
- can lower the signal latency is as low as 0.16ms, bringing super-fast transmission and hand response
- Transmission distance up to 100ft
- Charging compartment that can fully charge transmitter in 2 hours.

★ Starred items already discounted, not subject to further discounts — NET PRICES

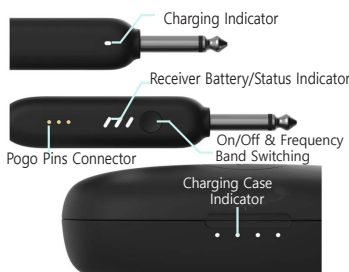

P7785

AMPLIFIER CABLE

P7118 **18'** \$12.95..... \$10.36

P7118



GUITAR AND UKULELE RESOURCES

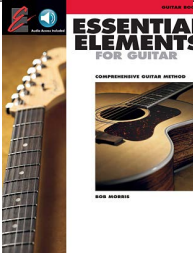

ESSENTIAL ELEMENTS GUITAR NEW

P9380 ESSENTIAL ELEMENTS FOR GUITAR ...\$22.99★
A comprehensive guitar method designed to meet the National Standards for Music Education, with cross-curricular activities, quizzes, multicultural songs, basic improvisation and more!

P9381 ESSENTIAL ELEMENTS FOR GUITAR ...\$24.99★
BOOK 2

Continuation of the concepts and skills taught in Book 1

P9382 DAILY GUITAR WARM-UPS ...\$16.99★
Wide variety of exercises to help get your hands in top playing shape.

ESSENTIAL ELEMENTS UKULELE

P9340 ESSENTIAL ELEMENTS FOR UKULELE ...\$9.99★
Chord strumming skills; HOW to practice; note reading exercises; "chord challenges" to learn chord progressions; tab reading; and more.

P9343 ESSENTIAL ELEMENTS FOR UKULELE ...\$14.99★
BOOK 2

Next step for players who are ready to expand their knowledge of music and further develop their skills on the ukulele.

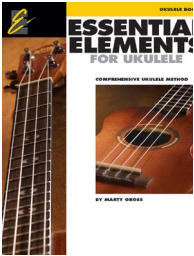

GUITAR AEROBICS NEW

One-lick-per-day workout program for developing, improving, and maintaining guitar technique -audio access included by Chad Johnson.

P9385 GUITAR AEROBICS ...\$24.99★

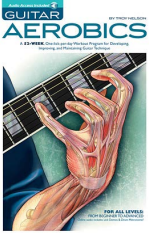

UKULELE AEROBICS

One-lick-per-day workout program for developing, improving, and maintaining ukulele technique -audio access included by Chad Johnson.

P9372 UKULELE AEROBICS ...\$22.99★

P9373 UKULELE AEROBICS BARITONE ...\$17.99★

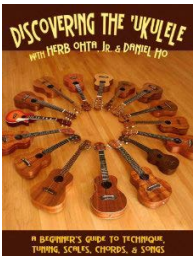

UKULELE METHOD

P9306 THE COMPLETE UKULELE METHOD ...\$20.99★
Intermediate Ukulele, By Greg Home and Shana Eisenberg/ Ed. Daniel Ho, Book and DVD.

P9325 DISCOVERING THE UKULELE ...\$15.95★
By Herb Ohta Jr, and Daniel Ho with free MP3 audio files.

P9326 EXPLORING THE UKULELE ...\$15.95★
Herb Ohta Jr, and Daniel Ho with MP3 audio files of music.

P9327 UKULELE : A BEGINNING METHOD DVD ...\$24.95★

by Daniel Ho

P9371 ITS UKULELE TIME ...\$5.99★

Learn how to play the ukulele using all-time favorite songs By Ron Manus and L.C. Harnsberger

P9374 JAKE SHIMABUKURO TEACHES UKULELE NEW ...\$22.99★

Learn notes, chords, songs, and playing techniques from the master, Jake Shimabukuro! Book with online video.

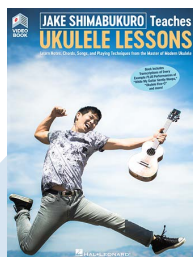

The musical instruments in our catalog are not toys. They are intended for use by adults and children with adult supervision. Unless otherwise stated, the instruments are not recommended for children under 3 years of age.

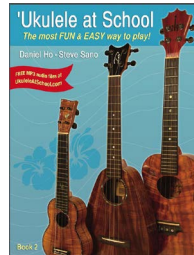

THE UKULELE AT SCHOOL

music professor Steve Sano, and six-time GRAMMY award winner Daniel Ho bring you this unique and empowering method that makes learning fun and easy!

P9332 THE UKULELE AT SCHOOL BOOK 1- TEACHERS GUIDE ...\$24.99★

P9331 THE UKULELE AT SCHOOL BOOK 1 ...\$15.99★

P9332 THE UKULELE AT SCHOOL BOOK 2- TEACHERS GUIDE ...\$24.99★

P9333 THE UKULELE AT SCHOOL BOOK 2 ...\$15.99★

ALFRED'S UKULELE METHOD

Instructional series by Ron Manus and L.C. Harnsberger

P9301 ALFRED'S BASIC UKULELE METHOD ...\$9.99★
Covers how to hold your ukulele, tuning your ukulele, right and left handed techniques, the basics of reading music, chords, and strumming patterns, songs, and how to read TAB. companion audio tracks that can be downloaded or streamed online.

P9302 ALFRED'S BASIC UKULELE METHOD ...\$14.99★
Book, DVD, and Online Audio

P9304 ALFRED KID'S UKULELE COURSE ...\$25.99★
Method that teaches kids to play songs on the ukulele. Includes accompanying online audio.

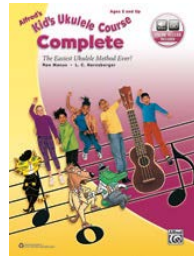

DAILY UKULELE SERIES BY LIZ AND JIM BELOFF

P9360 THE DAILY UKULELE ...\$44.95★
365 Songs for Better Living

P9361 THE DAILY UKULELE TO GO ...\$39.99★
Smaller Version of the Above Classic

P9362 THE DAILY UKULELE BARITONE ...\$49.99★

P9363 THE DAILY UKULELE LEAP YEAR EDITION ...\$44.99★

366 More Great Songs for Better Living

P9365 THE DAILY UKULELE BARITONE ...\$39.99★
LEAP YEAR EDITION

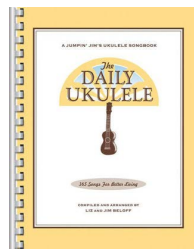

Educator or Educational institution status is required for discounted pricing featured in this catalog.

CHORD CHARTS AND DICTIONARIES

P9307 DANIEL HO UKULELE CORD CHART ...\$4.99★

P9321 UKULELE CHORD DICTIONARY ...\$5.99★



Classroom Publications on Page 74-77

Register for educator account at Peripole.com

DRUM KITS

TAMA IMPERIALSTAR COMPLETE 5 PIECE DRUM KIT W/CYMBALS



The total drum set package. Includes everything you need to get playing! Includes:

- Drums: 20"x16" bass drum, 10"x7" & 12"x8" tom toms, 14"x13" floor tom, 14"x5" snare drum.
- Hardware: Double tom holder, hi-hat stand, single drum pedal, snare stand, boom cymbal stand, straight cymbal stand, drum throne.
- MEINL "HCS" cymbals (14"HH+16"C+20"R) are included.



NEW!

The Stagestar series is a complete drum set package available in a variety of colors. This kit includes:

- Drums: 22"x16" Bass drum, 10"x8" tom tom, 12"x9" tom tom, 16"x15" floor tom, 14"x5.5" snare drum
- Hardware: Double tom holder, drum pedal, snare stand, boom cymbal stand, hi-hat stand, drum throne
- Cymbals: 14" Hi-hat cymbals (pr), 16" crash ride cymbal.



NEW!



DDRUM D2 COMPLETE 5 PIECE DRUM KIT

P4990\$670.00★

Total drum set package. Perfect for students and intermediate players. Includes everything you need in a beginner drum set. Includes:

- Drums: 8"x10" rack tom, 9"x12" rack tom, 14"x16" floor tom, 6.5"x14" snare drum, 18"x22" bass drum.
- Chrome hardware stands: hi-hit, snare stand, boom stand.
- Cymbals: 16" crash, 14" hi-hats (pr)
- Other: Drum throne, bass drum pedal, drum sticks.

TAMA STAGESTAR COMPLETE 5 PIECE DRUM KIT

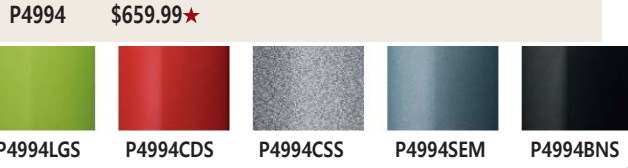

SINGLE BASS DRUM PEDAL

P4999\$92.00★

Solid base plate, concentric drive, and felt-lined channel. Four-way plastic/felt beater. Hoop clamp is adjusted from the side of the pedal, allowing for easy attachment to the bass drum.



NEW!



NEW!

5 PIECE CYMBAL AND SNARE STAND SET

P4998\$395.00★

Includes: 3-legged hi-hat stand, snare drum stand, boom cymbal stand, straight cymbal stand, and bass drum pedal. Cymbals sold separately.

SABIAN SBR 5 PIECE DRUM KIT CYMBAL PACK

P3700\$314.99★

All you need for your drum kit in one pack. Sonically matched with a hand hammered and lathed surface, SBR cymbals are in a class of its own. Includes: 14" hi hats, 16" crash, 20" ride, 10" splash



NEW!

MORE CYMBALS ON PAGE 44

DRUM PRACTICE PAD

P4890 \$50.10..... \$40.08

10" tunable practice drum pad. Fully mountable with changeable head.



† Not Illustrated

ELECTRONIC DRUMS

NEW!

E-FLEX COMPLETE ELECTRONIC DRUM KIT

P8870\$479.00★

The DDrum E-Flex has great feeling and responsive mesh heads on all 3 toms and the 2-zone snare pad. Both the hi-hat and bass drum controller pedals were designed to feel and respond naturally while keeping the set-up simple. The E-Flex also features a Double Bass Mode, allowing a player to use the hi-hat controller as a second bass drum.

Includes: three 6" mesh tom pads, 6" dual zone snare pad, 9" crash cymbal w/choke function, 9" ride cymbal w/bell zone and choke function, 9" high hat pad, bass and hi hat controller pedals, drum throne, complete rack, and pair of drumsticks.

- 12 Preset drum kits with great sounds
- Double Bass mode
- Onboard Metronome
- Sleek and compact design for smaller footprint



P8870

PIANOS AND STANDS

NUX PORTABLE DIGITAL PIANO

P8860\$499.00★

NEW!



P8860

EFFECTS AND FUNCTIONS

- Triple sensor scaled hammer-action keyboard with 5 types of touch sensitivity: super light/light/medium/heavy/super heavy.
- Reverb and Delay: 5 types (Hall/Church/Plate/Stage/Delay; reverb depth adjustable), Chorus: 4 depth levels, Tone Brilliance: 5 levels, Dual/Layer.
- Twin Piano: Split point adjustable; individual octave shift and tone selection.
- Octave Shift: -1 to +1 octaves
- Bluetooth: AUDIO and MIDI
- Metronome: 9 beats, tempo range 20 to 280 bpm
- Recording: 1 song (approx. 18000 notes total)
- Sustain pedal included

SPECIFICATIONS

- USB MINI, AUX In, Line Out (L/Mono, R), Headphones X2, Damper pedal jack, Connector for 3 pedal unit
- DC 12V/2A power source
- weight: 26.89LBS
- Preamp and two 10 WATT oval speakers



P8861

NUX WOOD PIANO STAND WITH 3 PEDALS

P8861\$159.00★

Stand for NUX Portable Digital Piano. Includes 3 pedals: sustain, sostenuto, and soft.

NEW!

EZ HEIGHT ADJUSTABLE BENCH

P8108\$179.65★



P8108

- EZ Height Adjustment lever with 4 height settings.
- Micro Adjuster fine tunes height setting.
- Adjustable Rubber Foot provides stability on uneven floors.
- folds flat for easy to transport.

PADDED PIANO BENCH

P8862\$79.00★

P8862



The musical instruments in our catalog are not toys. They are intended for use by adults and children with adult supervision. Unless otherwise stated, the instruments are not recommended for children under 3 years of age.



P8106

HERCULES X STANDS

For Pianos and Keyboards

P8106 EZ-Lok Single X Stand\$96.15★
 P8107 EZ-Lok Double X Stand\$115.50★

- The EZ-LOK System automatically locks the stand in place.
- Adjustable Rubber Foot provides stability on uneven floors.
- 5 height settings, and heavy-duty steel construction.

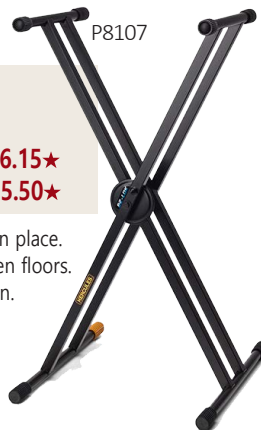

P8107

★ Starred items already discounted, not subject to further discounts — NET PRICES

 Educator or Educational institution status is required for discounted pricing featured in this catalog.

LIVE MICROPHONES

SAMSON AUDIO MICROPHONE Q6
P9902\$49.95★

Samson's Q6 Dynamic Microphone brings a high level of accuracy and audio performance to a variety of live and studio applications, including miking vocals, guitar cabinets, drums, and more. Designed for accuracy, as well as durability, the Q6 is a solid performer no matter the environment. As the Q6 is equipped to handle high SPLs, it allows live vocals to sound huge and crystal clear, but it is also great for miking instruments such as snare drums, guitar amps, and more.



Educator or Educational institution status is required for discounted pricing featured in this catalog.

RECORDING MICROPHONES

LM10X OMNIDIRECTIONAL LAVALIER MICROPHONE W/MINATURE CONDENSER CAPSULE
P9905\$109.99★

A discreet, omnidirectional lavalier microphone with a miniature condenser mic capsule that provides outstanding audio reproduction. Included adapter cables ensure an instant connection with most other popular wireless systems.



APOGEE HYPE MICROPHONE
P9900\$349.00★

HypeMiC features studio-quality analog compression that's easy to use and brings the magic to your vocals, voice-overs, instruments, percussion, and podcasts – anything you record!

- Studio-quality analog compressor
- Headphone output with Blend feature offers zero latency recording
- Premium accessories kit includes tripod, pop filter and carrying case
- No configuration required, just plug in and record with any audio app
- Works with iOS, Mac, and PC

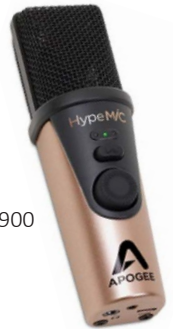

P9900

XPD2 HEADSET USB WIRELESS SYSTEM
P9904\$149.95★

Offering simple setup, professional full-range audio and 100 feet of wireless operation. The XPD2 Headset is perfect for live performances, digital communications and mobile productions.

- 2.4GHz USB digital wireless system, includes power pack, USB adapter, and headset microphone.
- Plug-and-play operation with Mac and Windows. Works with other Android and Mac devices via adapter.
- Transmitter offers 20 hours of battery life using two AA batteries
- Ideal for broadcasting, live streaming, presentations and more



P9901

SAMSON AUDIO MICROPHONE Q2U
P9903\$89.95★

The Q2U microphone is one of the best microphones for podcasting and home recording. The flexibility of the USB and XLR outputs make it an ideal tool for someone getting started by recording direct to a computer, and can continue to be used as studios grow to include mixers and audio interfaces.

- USB output for connecting to any Mac or PC device
- XLR output for connecting to any mixer/PA system
- Includes mic clip, tripod stand, tripod stand extension, USB cable (2.25m) and XLR cable (3m)



P9903

CLIP-ON PICKUP FOR ACOUSTIC INSTRUMENTS
P9912\$139.99★

Clip on pickup for acoustic instruments, can be used with any instrument with a sound hole.



P9912



MICROPHONE CABLE
P9907 25' \$19.95..... \$15.96



P9907

POP FILTER
P9910 \$27.49... \$21.99

Dual-layer 4.75" nylon mesh screen that reduces the vocal popping sounds.



P9910



BLUE YETI X PLUS PACK MICROPHONE
P9911\$199.99★

Blue Yeti X is a state-of-the-art flagship USB microphone for live recording. With an all new four-capsule condenser array inside, Yeti X delivers legendary Blue broadcast sound with great focus and clarity. Illuminated multi-function smart knob lets you monitor and adjust your voice level in real time, providing precise control over your audio stream.



P9911



SAMSON EXPEDITION XP1000 1000 WATT PORTABLE PA SYSTEM

P9909

.....\$1199.99★

Samson's Expedition XP1000 Portable PA system is an all-in-one sound system with incredible features and tons of power that packs into a single compact design. It's perfect for live music performances, DJ sets, parties, group exercise classes, office presentations, academic lectures and anywhere else you want great sound.

Features:

- Bluetooth-enabled, allowing you to wirelessly stream music from your smartphone, tablet or laptop.
- Removable 10-channel mixer with an impressive 1,000-watt (2x500), lightweight Class D amplifier.
- Mixer features 4 Mic/Line input channels, each with XLR and 1/4" inputs for connecting microphones or active line level instruments. Also includes 3 stereo input channels for connecting external devices like MP3 players, keyboards, and more.
- Each channel features Bass and Treble controls and the first two Mic/Line channels have a selectable compressor to even out levels while preventing overload and distortion.
- 16 presets of DSP effects.
- Stereo monitor outputs with level control to use system with additional powered speakers. Mixer has a Phantom Power switch to enable the integration of condenser microphones into your PA setup.
- Packs up into a single portable unit that weighs just over 50lbs.



P9909

NEW!

Also Includes:

Dual 2-way speaker enclosures with 10" woofers, removable 10-channel mixer with 16 presets of 24-bit digital effects, integrated 1-3/8" speaker stand mount, and speaker cables.

2 SPEAKER STAND SET

P9908 ~~-\$109.99~~..... \$98.99

Pair of lightweight, telescoping tripod speaker stands features steel-constructed design with a sleek black finish. With standard 1 3/8" pole adapters, stands fit virtually all PA speakers. Adjustable up to 5.25' in height, can handle enclosures that weigh up to 44 pounds (20kg) and have a locking latch for increased support.



NEW!

P9908

Register for educator account
at Peripole.com

MICROPHONE STANDS

HERCULES MIRCROPHONE HOLDERS

P8104 EZ Microphone Clip\$19.90★
Fits all standard size mic stands.

P8105 EZ Microphone Holder\$19.90★
Fits all mic stands without top washers.

Connects to a mic stand with the flip lever. Works with both threaded and non-threaded stands. Rubber lined for a secure grip.



† Not Illustrated

NEW!

HERCULES EZ CLUTCH TRIPOD BOOM MICROPHONE STAND WITH EZ MIC CLIP

P8103\$115.50★

- EZ Clutch easily adjusts and securely locks to desired height.
- 2-in-1 Boom Clamp with Single Knob Adjustment safely secures boom length and angle.
- EZ Boom Flip Clip releases and locks into position easily securing boom clamp in place.
- EZ Adaptor Flip Clip quickly secures mic clip in place and fits all standard size mic stands.

P8103

HERCULES QUICK-TURN H BASE MICROPHONE STAND

P8100\$41.70★

- Height adjustment is easy and fast with Quick Turn design.
- The Weighted HERCULES H-Base provides exceptional stability with space saving design.
- Lightweight and durable.
- Microphone clip/holder not included.

P8100

★ Starred items already discounted, not subject to further discounts — NET PRICES

HERCULES EZ HEIGHT ADJUSTMENT MICROPHONE STANDS WITH EZ MIC CLIP

P8101\$115.50★

Transformer Microphone Stand W/EZ Mic Clip

P8102\$60.45★

Tabletop Microphone Stand W/EZ Mic Clip

- EZ Height Adjustment Grip with easy trigger action releases and locks into position with a squeeze of the handle.

- The Tilting Base allows shaft to be set at desired angle. (45°-90° recommended.)

- The Wide-Base, Tripod Swivel Legs adjust independently, fit around other equipment easily, and fold up compactly.

- The EZ Adaptor Flip Clip quickly secures mic clip in place and fits all standard size mic stands.

P8101

P8102

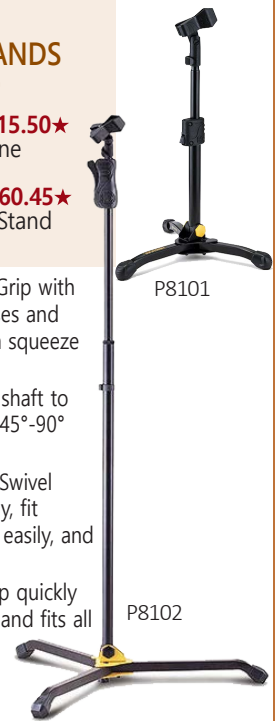

† Not Illustrated

MUSIC STANDS



HIGH QUALITY FOLDING MUSIC STAND

P9950 ~~\$25.95~~..... **\$20.76**

P9950



DELUXE FOLDING MUSIC STAND

P9965**\$54.95★**

Crafted to be stable whilst remaining easily adjustable, these stands feature a folding tripod base for mobility, large desk and spring loaded page holders, and a knob to lock the desk at any angle! Easy and sturdy height adjustments.

P9965



P9971



P9974

MANHASSET MUSIC STAND ACCESSORY SHELF

P9974 ~~\$12.99~~..... **\$10.39**

16" Long, durable ABS plastic shelf slides onto the ledge of your stand, instantly converting it to a double lipped orchestral stand.

TWO IN ONE TABLET AND PHONE HOLDER

P8109**\$60.45★**

Attaches to a desk, round and square tubes like keyboard stands, microphone stands, or music stands.



MANHASSET FLOOR PROTECTORS

P9973 ~~\$9.99~~..... **\$7.99**

Vinyl protector slips easily onto the base "toes" and stay firmly in place to prevent any unnecessary scratching of floor surfaces.



P9973



P9976

MANHASSET STAND CARTS

+ P9975 25 Stand Cart**\$565.34★**

P9976 13 Stand Cart**\$369.82★**

Welded steel construction, durable powder coated finish, high-density polyethylene rail liners and wheels it will provide service for years to come. It comes packaged with all the nuts and bolts necessary to easily assemble in minutes.

★ Starred items already discounted, not subject to further discounts — NET PRICES

INSTRUMENT STORAGE



P7032

MADE IN USA

P7035 Cases only Cart for 20 Guitar Cases**\$1,359.00★**

P7036 Guitars only Cart for 18 Guitar**\$1,376.00★**

P7037 Hybrid Cart for 9 Guitars and 10 Cases**\$1,372.00★**

- Multiple shelf configurations: guitars only, cases only or hybrid
- Securely holds up to 18 guitars or 20 cases
- Guitar model has uniquely shaped rails to cradle guitars securely
- Case model features steel-reinforced rails
- Heavy-duty wheels with brakes

P7031 Multi Sized Cart for 18 Ukuleles.....**\$898.00★**

P7032 Multi Size Cart for 30 Ukuleles.....**\$969.00★**

- Soprano only or multi-size versions
- 18 or 30 ukulele capacity
- Soft cushioning or felt for instrument protection
- Wheels with brakes
- Easy assembly
- Made In USA



P7037

MADE IN USA



Educator or Educational institution status is required for discounted pricing featured in this catalog.

INSTRUMENT STORAGE



GUITAR WALL HANGER WITH HARDWOOD BACK

† P7111	Hardwood Back	\$18.99.....	\$16.14
P7112	Metal Back	\$18.99.....	\$16.14

• Includes Hardware P7112

UKULELE WALL HANGER WITH HARDWOOD BACK

† P7113	Hardwood Back	\$18.99.....	\$16.14
P7114	Metal Back	\$18.99.....	\$16.14

• Includes Hardware

NEW!

HERCULES AUTOGRIP WALL HANGERS

† P8112	STEEL MOUNT\$30.20★	
P8113	WOOD MOUNT\$30.20★	P8113

- Auto-Swivel Yoke allows for multi-angle adjustments while safely locking instrument in place.
- can accommodate a wider range of instrument neck sizes from 40mm – 52mm.
- The attached N.I.N.A. (Narrow Instrument Neck Adjustment, HA301) are specially designed to increase the thickness of AGS arms to accommodate narrow neck instruments from min. 28mm (1.10") like banjos and mandolins.



HERCULES MULTI-NECK INSTRUMENT STANDS

P8110	Triple Instrument Stand\$120.95★
P8111	Six Instrument Stand\$157.25★

For Guitars, Basses, Banjos, Mandolins, and Ukuleles

- Auto Grip Systems safely lock the instrument(s) in place. Designed to accommodate multiple instrument neck sizes from 28mm – 52mm
- The Instant Height Adjustment Clutch with Locking Pin adjusts stand height quickly, easily, and securely.
- The Folding Back Rests with multi-angle position adjustment support the instrument securely and fold up securely for travel.

TWO TIER UKULELE TREE RACK

P7038\$399.99★

- Holds Up to 16 Ukuleles,
- 7' High by 30" Diameter

THREE TIER UKULELE TREE RACK

P7039\$499.99★

- Holds Up to 24 Ukuleles,
- 7' High by 30" Diameter

LP PERFORMANCE MOUNTING TRAY

P3821\$79.99★

- Stand not included

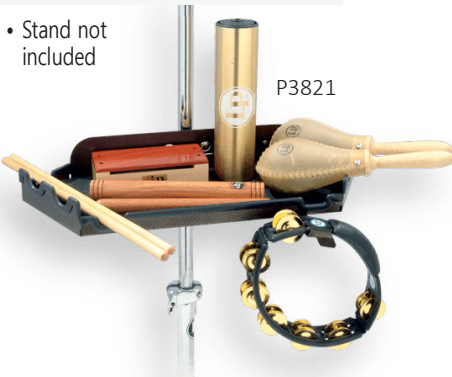

LP ASPIRE TRAY TABLE

P3820\$169.99★

- 22"W x 16"D rubber padded table with raised border to prevent falling instruments!
- Chrome plated, height adjustable stand is included



NEW!

PUBLICATIONS & MEDIA PRODUCTS BY AUTHOR

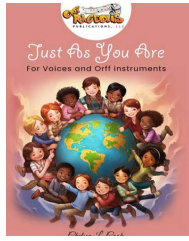
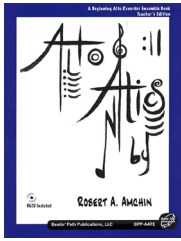

ROBERT AMCHIN

- P9110 MODAL MUSIC BOOK/CD** ...\$34.95★
Short pieces with Orff process lesson plans to kick start your students' composition and improvisation skills.
- P9111 MOODS & MODES BOOK/PACD** ...\$24.95★
Ensemble pieces for soprano and tenor recorder.
- P9112 AUTUMN SONGS** ...\$13.95★
Beautiful songs and instrumental pieces about Autumn from around the world.
- P9113 SPRING SONGS** ...\$24.95★
Beautiful songs and instrumental pieces about Spring from around the world.
- P9114 RECORDER FROLICS** ...\$19.95★
A beginning recorder ensemble book for soprano recorders. A tenor recorder part for an advanced student or the teacher and percussion parts are included as accompaniment.
- P9117 ALTO ANTICS BOOK/PACD** ...\$19.95★
A beginning alto recorder ensemble book. Contains percussion and Orff instrument accompaniments.

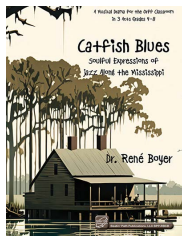
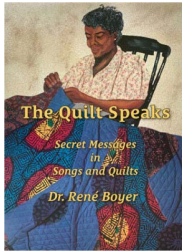

RENÉ BOYER NEW

- P9159 UNITED WE STAND - Complete** ...\$22.95★
Orchestration with Showtrax CD
- P9160 BALLAD OF THE UNDERGROUND** ...\$2.35★
RAILROAD (2 Part and Piano)
- P9162 SONGS & RHYTHMS OF A NATION**...\$34.99★
Explore the character of each state through folk songs.
- P9163 OUT OF THE MOUTHS OF BABES**...\$13.99★
The child's experience through song and poetry.
- P9164 SIGAME- A Journey Through** ...\$36.95★
Latin America Using Rhyme, Rhythm and Song
- Exciting songs, games, and instrumental accompaniments for teachers seeking to include Latin American rhythms, melodies, and harmonies in their classrooms.
- P9165 THE QUILT SPEAKS** ...\$29.95★
Using quilts and songs, enslaved were able to share messages that kept people safe along their long journey to freedom.
- P9166 CATFISH BLUES** ...\$31.95★
Soulful Expressions of Jazz Along the Mississippi, is a 3-Act musical written for children, Grades 4-8.

ERIC BRANSCOME NEW

- P9042 RHYTHM ACTIVITIES** ...\$24.95★
Innovative lessons range from playing rhythm, mallet instruments, to chants and rhythmic dictation.

CHELSEA COOK

NEW

- P9130 ACE OF SPADES** ...\$14.95★
- P9131 JUST AS YOU ARE** ...\$14.95★
- P9132 IT'S GOING TO BE A PARTY TONIGHT** ...\$14.95★
- P9133 USA LOVE** ...\$14.95★
- P9134 SLEIGH RIDE** ...\$9.95★
Medium difficulty, chromatic.
- P9135 BUTTERFINGER PIE** ...\$14.95★
Easy, diatonic.
- P9136 MUSIC MAKES THE WORLD GO ROUND** ...\$14.95★
Easy, diatonic.
- P9137 MR. WOODCHUCK** ...\$14.95★
Easy, diatonic.
- P9138 SALLY GO ROUND THE SUN** ...\$14.95★
Easy, diatonic.
- P9139 WADE IN THE WATER** ...\$14.95★
Easy, diatonic.
- P9140 TWINKLE TWINKLE LITTLE STAR** ...\$14.95★
Easy, for voices and orff instruments.
- P9141 HIP HOP BUNS** ...\$14.95★
Medium difficulty, diatonic.
- P9142 RUSSIAN DANCE** ...\$14.95★
The Russian Dance from the Nutcracker Suite. Hard difficulty, chromatic.
- P9143 HANUKKAH MEDLEY** ...\$14.95★
Medium difficulty, chromatic.

AIMEE CURTIS PFITZNER NEW

- P9635 PAINTED MUSIC** ...\$31.95★
Resource for elementary music teachers using Art and Music to activate Children's Literature.
- P9636 COLOR ME MUSIC** ...\$34.95★
Songs, games, and activities filled with sound colors inspired by the colors of life. For elementary students.
- P9637 SINGING WATERS, DANCING** ...\$31.95★
FLAMES
Using the four elements, this title features original songs and favorites with Orff arrangements, stories, games, and songs for elementary students.
- P9638 PLAYFUL POSSIBILITIES** ...\$31.95★
Musical, playful activities: Listening, moving, creating, playing instruments, and favorite children's books.

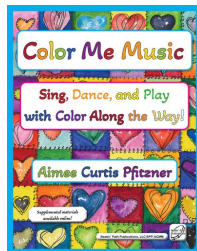

DAWN-EATON-MUIR NEW

- P9722 JAMAICA PLAY** ...\$29.95★
Ring Plays, Hand Plays, Rhymes and Rhythms from Jamaica. Includes translations, pronunciation guides, and complete directions for each activity.

DOUG GOODKIN

- P9180 INTERTY MINTERY** ...\$32.00★
48 arrangements and activities for preschool and elementary.
- P9181 THE ABC'S OF EDUCATION** ...\$18.00★
A provocative look at the ways in which today's schools are failing our children, and what teachers can do to restore the promise of education.
- P9182 NOW'S THE TIME: JAZZ FOR ALL AGES, BOOK** ...\$38.00★
Sequential approach for teaching jazz to all ages.
- P9183 NOW'S THE TIME-JAZZ FOR ALL AGES, Companion CD** ...\$25.00★
- P9184 NAME GAMES** ...\$14.95★
20 ways to learn names and create compositions.
- P9185 A RHYME IN TIME** ...\$14.95★
20 activities for music and language arts development.
- P9186 SOUND IDEAS** ...\$17.99★
Activities for percussion circle.
- P9187 PLAY, SING AND DANCE** ...\$26.95★
A comprehensive look at the various Orff media, with photos of children at The San Francisco School.
- P9188 ALL BLUES, JAZZY ORFF ENSEMBLES** ...\$38.00★
Supplement to Now's the Time with 35 new jazz pieces.
- P9189 TEACH LIKE IT'S MUSIC** ...\$20.00★
- P9192 JAZZ, JOY, AND JUSTICE** ...\$15.95★
The hidden stories of some of your favorite musicians.

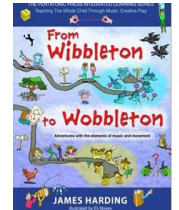

JAMES HARDING

- P9195 FROM WIBBLETON TO WOBBLETON**...\$32.00★
An in-depth look at creative play using the Orff-Schulwerk method.

KRISTA HART NEW

- P9232 THE MINDFUL MUSIC CLASSROOM**...\$24.99★
An approach to SEL through a musical lens, helping to identify and connect the most important competencies and skills with common musical scenarios and concepts.

BRENT HOLL

- P9660 SCHOOL SONGS (BOOK/CD)** ...\$29.95★
Easy, very singable songs for Social Studies, Science and Reading in the elementary classroom.
- P9661 SOUNDS ABOUND!** ...\$34.95★
Usage of harmony in the context of Orff Schulwerk and the orchestration techniques.
- P9662 SOUNDS ABOUND! VOL 2.** ...\$34.95★
Orchestration techniques for getting the most out of your own collection of classroom instruments.

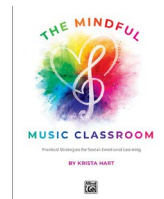
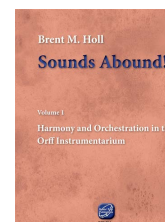

Guitar and Ukulele Publications on Page 67

DAVE HOLLAND

- P9450 BODY JAMMIN' (BOOK/DVD) ...\$29.95★**
An introduction to body music.
- P9451 INTERACTIVE RHYTHM (BOOK/DVD) ...\$29.95★**

Wide variety of games, songs and interactions designed to enhance any rhythm making experience.

- P9452 DRUMAGINATION (BOOK/DVD) ...\$29.95★**
Collection of activities that are easy to learn and are guaranteed to engage rhythm makers.

ALEJANDRO JIMINEZ

- P9220 PICANTE, CLASSROOM KIT ...\$49.99★**
General classroom music in styles of the Afro-Spanish-Caribbean. Ensemble pieces for grades 5-9.

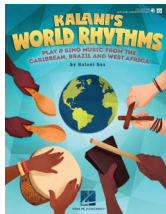
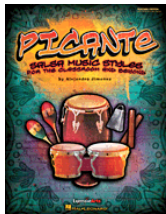

KALANI DAS

History, tuning, maintenance, techniques, exercises, ensembles, and more. Each book comes with an enhanced CD featuring additional multimedia content, including demonstrations of all rhythms and techniques and tuning instructions.

- P9500 ALL ABOUT HAND PERCUSSION ...\$18.99★**
- P9501 ALL ABOUT DJEMBES ...\$17.95★**
- P9502 ALL ABOUT CONGAS ...\$19.95★**
- P9503 ALL ABOUT BONGOS ...\$17.99★**

- P9504 TOGETHER IN RHYTHM ...\$25.99★**
Learn the art of drum-circle facilitation. DVD includes activities, games, an instrument guide and inspirational interviews.

- P9505 THE AMAZING JAMNASIUM ...\$19.95★**
A Playful Companion to "Together in Rhythm."

- P9506 WEST AFRICAN DRUM AND DANCE TEACHER EDITION ...\$41.99★**

Book/DVD/CD set is a curriculum for the study of West African Music using Mandé Instruments. Feature authentic village scenes and step-by-step instruction.

- P9507 WEST AFRICAN DRUM AND DANCE STUDENT EDITION ...\$8.99★**

- P9510 RECORDERS IN RHYTHM ...\$13.99★**
Recorder with Latin percussion using authentic Caribbean rhythms. Includes audio/video CD.

- P9512 DRUM FUN DVD SET ...\$21.95★**
Over 25 music-based activities.

- P9513 PLAY UKULELE DVD BY KALANI ...\$15.95★**
Complete program for anyone who wants to play ukulele.

- P9514 PLAY CONGAS DVD BY KALANI ...\$15.95★**
Complete guide to learning and teaching the congas.

- P9515 THE WAY OF MUSIC CREATING SOUND CONNECTIONS IN MUSIC THERAPY ...\$32.00★**

Pathways into the world of improvisational music therapy. A progressive and holistic process of sound exploration.

- P9516 FLUTE MASTERY DVD (NATIVE AMERICAN FLUTE) ...\$15.95★**
twenty-two different techniques using finger, breath, tongue and voice.

- 9518 PLAY CAJON DVD ...\$15.95★**

Basic and advanced techniques.

- P9519 THE HEALING FLUTE DVD ...\$15.95★**

Lessons for beginners and beyond with mind-body practices designed to increase health and well-being.

- P9530 KALANI'S WORLD RHYTHMS ...\$54.99★**

Play and sing music from the Caribbean, Brazil, and West Africa! Includes online video and audio.

- P9550 RHYTHM SPIRIT CD ...\$5.99★**

World-rhythm beats combined with spirited songs from West Africa, Brazil, Latin America and beyond.

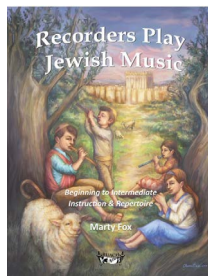
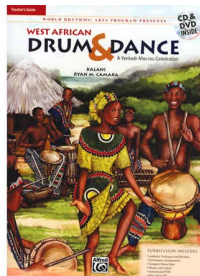

MARTY FOX

Jewish music and the historical importance of music in Judaism.

- P9045 RECORDERS PLAY JEWISH MUSIC...\$30.00★ TEACHER'S EDITION**

- P9046 RECORDERS PLAY JEWISH MUSIC...\$15.00★ STUDENT EDITION**

MELANIE KANG

NEW

- P9720 LIONS, LANTERNS, & RIBBONS ...\$34.95★**

Celebrate the Chinese New Year in movement and song.

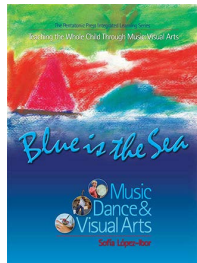
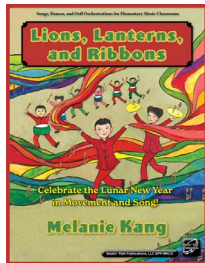

SANDY LANTZ AND GRETCHEN WAHLBERG

- P9640 DRUM IT UP ...\$24.95★**
everything from easy hand drum pieces using the echo process, to show stoppers.

- P9642 STRUM IT UP ...\$26.95★**
Integrates Ukuleles with other classroom instruments and has full Orff-style orchestrations.

- P9643 CREATIVE BITS WITH CHILDREN'S LIT ...\$26.95★**

Children's books come alive in your music classroom with the songs and creative lesson plans.

- P9644 S'MORE BITS WITH CHILDREN'S LIT ...\$31.95★**

More of your favorite children's books with songs and creative Orff process lesson plans.

- P9645 MIXING IT UP! ...\$31.95★**

From beginning ukulele and recorder pieces to more challenging drum and mallet selections, lesson plans are written as recipes for process teaching. This book strives use all your musical "stuff" with Orff process.

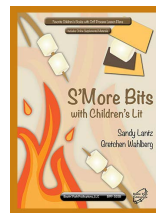

CHRIS JUDAH-LAUDER

- P9620 CANYA CONGA (BOOK/CD ROM)...\$24.95★**

Orff lesson plans, including objectives and extensions plus full scores. Ways to adapt and include everyday household items in the drum ensemble.

- P9621 DRUM WITH A PASSION ...\$31.95★**

Collection of energetic, child-ready drumming activities.

- P9622 HAND DRUMS ON THE MOVE ...\$19.95★**

Musical score alongside Orff teaching process, ideal for a beginning teacher or someone new to hand drums.

- P9623 TO DRUM ...\$13.95★**

Drumming activities for grades 1 - 8. Orff process lesson plans and full scores.

- P9624 IN THE MODES (BOOK/CD ROM)...\$34.95★**

Features the ancient modes as a great way to promote improvisation and instrument technique.

- P9626 GAMES, GROUPS, AND GEMS ...\$26.95★**

These activities will have your students moving, singing, playing, and learning!

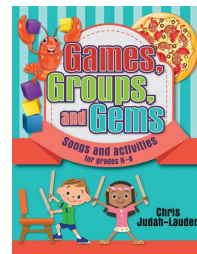

SOFIA LOPEZ-IBOR

- P9210 BLUE IS THE SEA ...\$45.00★**

25 themes with music, poetry, dance and visual art activities for preschool through middle school students.

- P9211 QUIEN CANTA SU MAL ESPANTA!...\$39.95★ SINGING DRIVES AWAY SORROW!**

Bilingual book and DVD presents a rich selection of material from an immense geographical area, combining local traditions with foreign influences.

SHERRY LUCHETTE

The Flying Jazz Kittens Primary Series: Jazz Activities and Songs for the General Music Classroom.

- P9200 THE FLYING JAZZ KITTENS (BOOK/CD) ...\$30.00★**

- P9201 THE JAZZY KITTEN TREE (BOOK/CD) ...\$30.00★**

- P9202 THE VIKING PINEAPPLES (BOOK/CD) ...\$30.00★**



PUBLICATIONS & MEDIA PRODUCTS BY AUTHOR

CAK MARSHALL

- P9600 TOOTLES** ...\$7.50★
Learn to play fun, engaging recorder trios!
- P9601 TOOTLES 2** ...\$7.50★
Even more fun recorder trios!
- P9610 BEATWORX** ...\$8.95★
Collection of melodies for use with non-pitched rhythm instruments.
- P9611 SOUND STORIES** ...\$8.95★
A collection of six original scenarios, written to help children identify the four major non-pitched sounds.

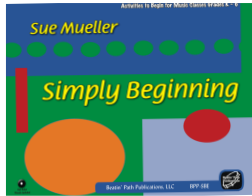
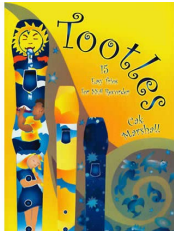

SUE MUELLER

- P9709 SIMPLY BEGINNING** ...\$31.95★
Grounded in Orff Schulwerk process, activities and suggestions for beginning each new type of activity in the school year.
- P9710 SIMPLY SPEAKING** ...\$26.95★
Orff style activities for the music classroom centered around the idea of speech, chants, and word rhythms.

RAY MULLINS

- Irish and Irish-American songs with beginner, intermediate, and expert recorder parts and guitar chords.
- 9490 CELTIC CROSSINGS** ...\$22.00★
- 9491 CELTIC CROSSINGS 2** ...\$18.00★

GRACE NASH

- P9000 5 - MINUTE GET UP AND GO'S FOR EVERYONE, BOOK** ...\$12.95★

JACKELINE RAGO

- P9240 VAMOS POR EL MUNDO, CD** ...\$15.00★

KONNIE SALIBA

- P9730 FORGOTTEN TREASURES** ...\$29.95★
Folk Songs, Games, and Activities for Orff Classes.
- P9732 TREASURES FROM THE ORFF ATTIC** ...\$19.95★
Songs, Dances, Chants, and Orff Instrumental Accompaniments for Elementary and Middle School.

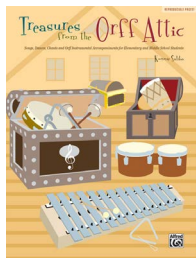

MARI SCHAY

- P9123 RHYTHM-O-RAMA!** ...\$34.99★
Featuring Pop Hits, Movie Themes, and Showtunes Arranged for Classroom Percussion Instruments.
- P9124 ROCKIN' THE RADIO** ...\$29.99★
Pop Arrangements and Teaching Strategies for Orff Instruments.

WILL SCHMID

An enhanced curriculum sequence including creative ideas and teaching strategies. Includes audio recordings, "how-to" videos, and projectable PDF's.

- P9400 WORLD MUSIC DRUMMING COMPLETE CLASSROOM KIT 20TH ANNIVERSARY SET** ...\$84.99★
- P9404 WORLD MUSIC DRUMMING, NEW ENSEMBLES AND SONGS** ...\$21.99★
Supplements the original World Music Drumming curriculum. Book and playalong CD.
- P9405 WORLD MUSIC DRUMMING, MORE NEW ENSEMBLES AND SONGS** ...\$21.99★
Further supplements the original World Music Drumming curriculum. Book and playalong CD.
- P9406 PEANUT BUTTER JAM COMPLETE KIT** ...\$49.99★
Calypso, rock, swing, Middle Eastern patterns and more!
- P9407 PEANUT BUTTER JAM TEACHER EDITION** ...\$27.99★
- P9408 PEANUT BUTTER JAM ACCOMPANIMENT CD** ...\$34.99★
- P9409 BEAT BOX - WORLD MUSIC DRUMMING 101** ...\$29.99★

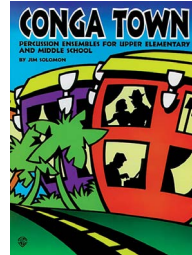

JIM SOLOMON

- P9470 HOT JAMS FOR RECORDER WITH GUITAR AND DRUM - BOOK/CD** ...\$24.99★
A collection of original recorder pieces is accompanied by guitar and drum.
- P9471 HANDS ON - A ROCKIN' RHYTHMIC ROMP** ...\$16.95★
From pure conga jams to timbre studies to polymetric rhythms.
- P9472 D.R.U.M. DISCIPLINE, RESPECT, AND UNITY THROUGH MUSIC** ...\$19.99★
- P9473 CONGA TOWN: PERCUSSION** ...\$19.99★
Ensembles for upper elementary and middle schools.

BOOMWHACKER RESOURCES

- P9250 WHACK-A-DOODLE-DO** ...\$6.50★
19 Familiar children's songs and 1 original song.
- P9251 WHACK-A-DOODLE-TOO** ...\$3.25★
22 Familiar children's songs.

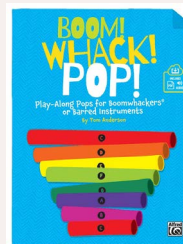
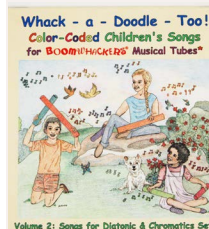

- P9252 BOOM! WHACK! POP!** ...\$4.99★
Play along with your favorite pop tunes in this fun and engaging collection.

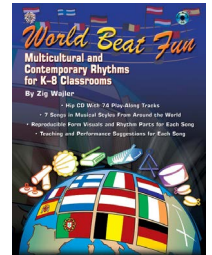
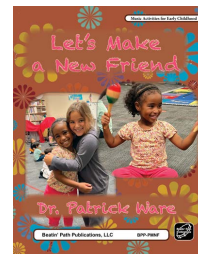

PATRICK WARE

- P9700 LET'S MAKE A NEW FRIEND** ...\$24.95★
Lessons with movement, singing, and playing instruments for our youngest students, PreK-2!
- P9701 THIS IS WHAT I CAN DO!** ...\$24.95★
Classic Orff process with some cool jazz riffs in arrangements of children's rhymes and original tunes.
- P9702 HERE'S TWO** ...\$24.95★
Jazz tunes for Orff classes containing teaching suggestions, full scores, and info about jazz styles.

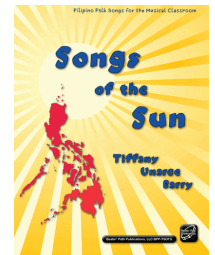
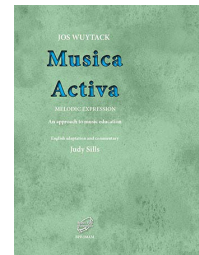

ZIG WAILER

- P9118 WORLD BEAT FUN** ...\$19.99★
Music technology integrates with world percussion to create an entertaining and educational collection of songs and rhythms.

JOS WUYTACK

- P9616 MUSICA ACTIVA** ...\$34.95★
This is an adaptation of Jos Wuytack's Musica Viva 2 - Expression rythmique, first published in French in 1982.

TIFFANY UNARCE BARRY

- P9724 SONGS OF THE SUN** ...\$26.95★
Songs and games from the Philippines with Orff process lesson plans.

BOOM-A-TUNES™ CURRICULUM SERIES:

- P9260 VOLUME 1** ...\$12.95★
Uses C major diatonic set. Grade K-3.
- P9261 VOLUME 2** ...\$12.95★
Uses C major diatonic, treble, extension, bass diatonic sets and octavator caps to introduce bass clef and grand staff reading. Grades 3-6.
- P9262 VOLUME 3** ...\$7.10★
Uses C major diatonic, treble extension, bass diatonic sets and Octavator caps to continue bass clef and grand staff reading. Grade 3-6.
- P9263 VOLUME 4** ...\$7.10★
Uses all Boomwhacker sets. Completes bass clef and grand staff reading. Grades 4-6.
- P9264 VOLUME 5** ...\$7.10★
Uses all Boomwhacker sets. Covers triplets, seventh chords and Latin rhythms, mixed meter, major/minor/perfect intervals and tempo markings. Grade 5-6.

MUSIC FOR CHILDREN VOLUMES

Carl Orff devoted much of his life to music for children. His pioneering work continues under the guidance of teachers and educators in many countries. The five basic German volumes of "Music for Children" by Carl Orff and Gunild Keetman were published between 1950 and 1954. The considerable growth of Orff-Schulwerk in the United States led to the publication of the American Edition (1977) to satisfy the requirements of a different educational system and national heritage.

PAUL CRIBARI & RICK LAYTON

Based on the models presented in Orff and Keetman's Music for Children volumes, this book is a must-have resource for teachers of the elemental style.

- P9095 THE ELEMENTAL STYLE ...\$34.95★**
P9096 THE ELEMENTAL STYLE VOL 2 ...\$34.95★



MUSIC FOR CHILDREN VOLUMES MARGARET MURRAY ENGLISH ADAPTATION

- P9271 VOLUME 1 ...\$29.99★**
Speech and rhythmic exercises, nursery rhymes, songs, instrumental pieces and melodic exercises using the five note scale.
- P9272 VOLUME 2 ...\$29.99★**
Songs using the full major scale.
- P9273 VOLUME 3 ...\$29.99★**
Range of keys are increased. Include the chords on the fourth and fifth notes of the major scale. The Dominant Triad.
- P9274 VOLUME 4 ...\$29.99★**
Songs using the full range of the Aeolian, Dorian and Phrygian modes.
- P9275 VOLUME 5 ...\$29.99★**
The Dominant Triad With Minor Third: Syng.

CLASSROOM RECORDER PROGRAMS

ARTIE ALMEIDA - RECORDER EXPRESS

Recorder Express - Recorder Express provides the classroom method to becoming a great recorder player and having fun! More than 120 folk, pop, and original songs and exercises are included, as well as technique tips and beginning music theory.

- P9080 BOOK ...\$8.99★**
P9081 BOOK & CD ...\$14.95★
P9082 CD ONLY ...\$12.99★
P9086 INTERACTIVE SOFTWARE ...\$29.99★

PENNY GARDENER - NINE NOTE

Music recorder program for classrooms and homes.

- P9040 THE NEW NINE-NOTE RECORDER METHOD, BOOK ...\$12.95★**
P9041 THE QUICK NINE-NOTE RECORDER METHOD, BOOK ...\$6.95★

DENISE GAGNE- COMPLETE RECORDER RESOURCE

Everything you need for teaching a first year recorder program.

- P9050 THE COMPLETE RECORDER RESOURCE KIT, TEACHER EDITION WITH CD ...\$40.00★**
P9051 THE COMPLETE RECORDER RESOURCE KIT, TEACHER BOOK WITH POWERPOINT & CD ...\$40.00★
P9052 THE COMPLETE RECORDER RESOURCE KIT, STUDENT EDITION ...\$5.00★
P9053 THE COMPLETE RECORDER KIT 2, TEACHER EDITION ...\$40.00★
P9054 THE COMPLETE RECORDER KIT 2, TEACHER BOOK WITH POWERPOINT & CD ...\$50.00★
P9055 THE COMPLETE RECORDER KIT 2, STUDENT EDITION ...\$5.00★

MARI SCHAY- RECORDER MONSTER

- P9120 RECORDER MONSTER TEACHER'S...\$32.95★**
BOOK WITH CD-ROM
P9121 RECORDER MONSTER STUDENT BOOK ...\$7.95★
P9122 RECORDER MONSTER INTERACTIVE LESSONS ...\$29.95★

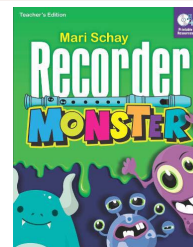
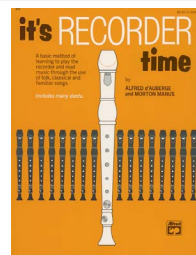

ALFRED D'AUBERGE AND MORTON MANUS

- P9100 IT'S RECORDER TIME - BOOK ...\$7.99★**

ERASABLE BOARDS

P8842 ERASABLE TEACHING BOARD ...\$36.99★
You'll never have to erase the chalkboard again! This unique set consists of six sturdy laminated chart boards with music staves, each 22.5" x 34.5". Write on them with dry erase markers and though they have the look of permanent markers. The Chart Boards are easily erased with a tissue.

ALFRED'S SIGHT-SINGING FLASHCARDS

P9758 ...\$34.99★
40 double-sided cards organized in four color-coded sets, including solfège syllables, Curwen hands signs, common 4/4 rhythms, intervals (both ascending and descending), plus simple melodic pitch patterns.



P8840 WIPE CLEAN MUSIC BOARD ...\$7.95★

These colorful boards are a fun way to practice notation. The red side is portrait-oriented with multiple staves; the reverse blue side is landscape oriented with a larger/longer set of staves. Includes a wipe-clean music pen, with an eraser on the end.

P8841 ERASABLE MUSIC LARGE BOARDS ...\$32.99★

10 board pack. Two staves are printed on one side for teaching musical notation; the other side is blank and may be used for drawing rhythms, musical symbols, terminology and just plain fun! Great for group work!

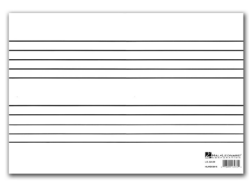

HAL LEONARD MUSICAL FLASHCARDS

- P9755 SET A ...\$8.99★**
120 color-coded cards to learn basic musical symbols, all notes from lower ledger C to high ledger C, and rhythm patterns in 4/4 and 3/4, staff steps and skips.
- P9756 SET B ...\$8.99★**
120 color-coded cards to review musical terms; key sig; and chord progressions in C, Am, G, Em, F, Dm, and rhythm patterns in 2/4, 3/4, 4/4, 3/8, and 6/8; interval cards, prime through octave.



Guitar and Ukulele Publications on Page 67

MANUSCRIPT PAPER

- P9750 WIREBOUND MANUSCRIPT PAPER...\$5.99★**
96-page wirebound book; 12 staves per page; 8 1/2" x 11".
- P9751 PAD OF MANUSCRIPT PAPER ...\$5.99★**
Tear off pad with firm backing; 32 sheets (64 pages) printed both sides; 12 staves per page; 8 1/2" x 11"; punched to fit all ring binders.
- P9752 GUITAR TAB MANUSCRIPT PAPER...\$7.99★**
96-Page wirebound book; 12 staves per page; 8 1/2" x 11".

**Please call for Special Discounts. For further information or to request a quote, please contact us.
PRICES ARE SUBJECT TO CHANGE WITHOUT NOTICE. Shipping charges will be prepaid and added to your invoice.**

Terms – If approved, Net 30 days from date of invoice.

Open account Billing – All public schools automatically have full open-account credit. Please include Purchase Order with all applicable orders. Individual teachers making purchases will be eligible for full school discounts, payable in advance by check or credit card (VISA, MasterCard, Discover or Amex).

Prompt Shipment of Order – Orders will normally be shipped within 2-4 business days via the most expeditious carrier, but for certain circumstances or items can take up to 30 days. In the interest of serving you more efficiently, we reserve the right to make partial shipment when a delay is unavoidable. We will bill only for shipped portions. Back ordered items will be shipped as soon as possible. If an item you ordered will be more than 30 days back ordered, our staff will reach out to inform you of all available options for your order.

We will not pay for expedited shipping and we do not accept COD's. We may, at our discretion, make alternative shipping arrangements with our customers.

Orders are shipped either from our facility in Salem, Oregon, or, at our discretion, we may have an item shipped directly from our supplier.

Shipments to Alaska, APO, Hawaii, us territories and other countries – Orders will be shipped by United States Postal Service or at times other carriers. Additional shipping charges apply outside the lower 48 states. Please contact us with your order information for shipping charges.

Shortage or damage in shipment – Please check contents carefully according to the enclosed packing slip. Be on the lookout for small items. Please report any discrepancy within 10 days. Should damage occur, please contact us at once to report damage or shortage. Please be mindful of the number of cartons to be received to make certain that none is missing and all have been received.

Discretionary Returns – We want you to be completely satisfied with your purchase. Discretionary returns are items that have no physical damage or defect, but the customer wants to return for another reason. Discretionary returns must have the return initiated within 30 calendar days of receipt of product and must be returned in new condition and in original undamaged packaging or no refund can or will be issued. Items returned under this policy must be shipped at your expense and are subject to a 10% restocking fee. If an item is received as a discretionary return and is not received in new condition and in original undamaged packaging, you will be notified that the item was not received in satisfactory condition and you may then choose to have the item returned to you at your expense or a lesser negotiated credit.

Once your return is approved, you have 30 days to ship back the item. If the item is not received within 30 days

of return approval, the return will be canceled.

OUR Triple Guarantee – Peripole, Inc. guarantees that all of our products are of excellent quality, workmanship, and that their musical function will be accurate, as intended. If an item is found to be of defective quality, workmanship, or musical function, it will be considered a defective item and will be subject to our defective item return policy. Further, we guarantee that we will, upon request, match or beat any currently advertised price on an identical item sold in the USA that is not in violation of the product manufacturers MAP policy. This advertisement must show that the advertised price is currently in effect.

Please Note: Due to hygienic considerations, all sales on instruments which are played by mouth (recorders, didgeridoos, whistles, etc.) are final, and they cannot be returned under our discretionary returns policy. If these items are defective, they can be exchanged for a replacement under our defective item policy.

Defective Item RETURN – We do our very best to send you items of only the highest quality possible, free of defects. If you happen to receive a defective item, please call our office at 503-362-2560 or 800-443-3592 (8:30am to 5:00pm Pacific Time) to initiate a defective item claim. Your claim will be evaluated and, if approved, our representative will send you a UPS pre-paid shipping label that you can use to return the item to us at any UPS shipping outlet.

It is the customer's responsibility to pack the item in such a way that it is well padded and protected, and is received in first-class, new condition. With the exception of the stated defect, if the item is not received in new condition, the item return will be evaluated and may be rejected as unreturnable at our discretion. Upon receipt of the item, and final approval of the defective item claim, a replacement item or items will be shipped to the customer at our expense by normal shipping methods previously stated. Should the customer request a refund instead of a replacement, this will fall under our discretionary returns and a 10% restocking fee will apply.

Credit card refunds can only be issued to the same credit card used in initial order in full amount of the order. Partial refunds can be issued via check upon request or credit can be added to your school or district account for the returned item(s). Credit cannot be issued for individuals.

All claims for defective items must be made as soon as the flaw is observable. All defective items claims must be made within 30 days. In special situations where inspection is delayed, this may be extended at our discretion up to 90 days maximum.

Items with a manufacturers warranty that exceeds our return policy timeline must have claims initiated through the original manufacturer. Peripole is not responsible for warranties issued by the manufacturer.

We reserve the right to make changes to our refund and return policy without prior notice. The current and complete policy is posted on our website, www.peripole.com.

DISCONTINUED ITEMS – We reserve the right to discontinue and/or replace any item without notice.

Changes in Design – It is the policy of Peripole Music and its suppliers, to constantly upgrade products. Therefore, we reserve the right to make changes in design and specifications and to ship the new product.

Order information

How to place orders –

- Call us at: 503-362-2560 or 800-443-3592

- Fax us at: 503-362-3231 or 888-724-6733

Note: Toll-free numbers only work within USA

- Email: contact@peripole.com

- Online: peripole.com

- Mail orders to address on the order form.

Please send a completed order form, or previously issued Peripole Music quote, and include Purchase Order if applicable. Please make certain to clearly indicate the exact quantity, catalog number and name of item desired. We accept check, credit card, and Purchase orders.

Credit card orders: We accept VISA, MasterCard, Amex or Discover. Please make certain to include account number and date of expiration, with 3 digit code on back of card (4 digits on front for Amex), and the card billing address.

C.O.D. SHIPMENTS – We do not ship any orders C.O.D.



Our Triple Guarantee
Quality and Workmanship
Musical Function
Price: We will match or
beat any advertised price on an
identical item.

© 2022 - Peripole, Inc.
Salem, Oregon
All rights reserved.



P.O. Box 12909
Salem, Oregon 97309-0909

PRINTED
IN USA

 PRINTED ON
RECYCLED PAPER

Peripole Music ... A Special UNIQUE Company

- ◆ All products subject to our Triple Guarantee!
- ◆ Sole source vendor!
- ◆ Exclusive products in design, musical purpose and manufacture!
- ◆ Online discounts for Music Educators
- ◆ Caring and personalized service ALWAYS!
- ◆ Fair and reasonable school prices ALWAYS!
- ◆ Total satisfaction ALWAYS!
- ◆ Nationally Awarded Cooperative Purchasing Vendor
- ◆ Founded by Music Educators to serve Music Educators!

Peripole® Instruments are the instruments of choice by the nation's leading music educators for LONG-TERM use!

Contact us for special discounts!

800-443-3592
503-362-2560
peripole.com

